



# Interface options for measuring and monitoring relays of the XM420 series



# Measuring and monitoring relays of the XM420 series



XM420 series

## Description

The standard measuring and monitoring relays of the XM420 series include two alarm relays with one changeover contact each. In addition the following options are available:

### Option M

Analogue output, galvanically isolated, output signal selectable via the menu:

- DC 0...400  $\mu$ A      current output for Bender measuring instruments of the 96...series.
- DC 0...10 V      standardized voltage signal
- DC 0/4...20 mA      standardized current output

### Option M1C

Analogue output 0/4...20 mA (not galvanically isolated), one changeover contact to be used as a freely configurable alarm message.

### Option M2C

Analogue output 0...400  $\mu$ A (not galvanically isolated), one changeover contact to be used as a freely configurable alarm message.

### Option M3C

Analogue output 0...10 V (not galvanically isolated), one changeover contact to be used as a freely configurable alarm message.

### Note:

The analogue output without galvanic separation is only suited for supply of measuring instruments or PLC inputs that are not galvanically connected to earth.

A galvanic connection of a measuring device output to earth may lead to fault messages on insulation monitoring devices IR42... and malfunctions of voltage relays VM...42....

## Device features

- Flexible interface options for devices of the XM420 series
- Easy transfer or transmission of measured values to instrumentation and control engineering
- Due to a galvanically isolated interface measured values are not adversely affected.

## Interface options

### Standard

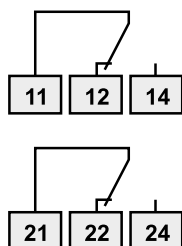
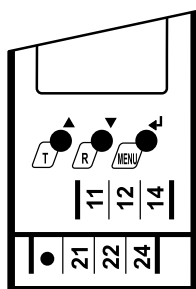

### Option M

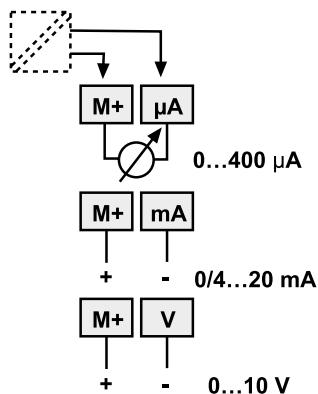
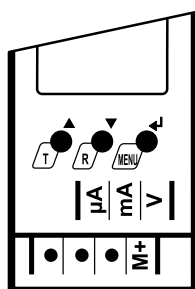

### Option M1C / M2C / M3C

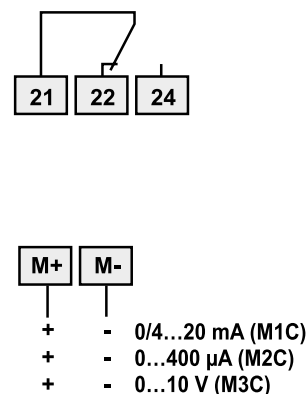
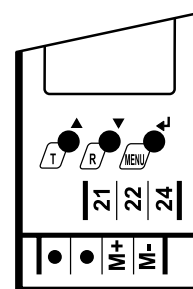

**Ordering information Standard**

Designation	Type	Art.-Nr.	
		Screw-type terminal	Push-wire terminal
INSULATION MONITORING DEVICE	IR420-D6-1	B91016415	B71016415
	IR420-D6-2	B91016407	B71016407
	IR425-D4-2	B91036402	B71036402
CURRENT RELAY 3ph	CMD420-D-1	B93060006	B73060006
	CMD420-D-2	B93060007	B73060007
	CMD421-D-1	B93060008	B73060008
	CMD421-D-2	B93060009	B73060009
CURRENT RELAY 1ph	CME420-D-1	B93060001	B73060001
	CME420-D-2	B93060002	B73060002
RESIDUAL CURRENT MONITOR	RCM420-D-1	B94014001	B74014001
	RCM420-D-2	B94014002	B74014002
	RCMA420-D-1	B94043001	B74043001
	RCMA420-D-2	B94043002	B74043002
	RCMA423-D-1	B94043023	B74043023
	RCMA423-D-2	B94043025	B74043025
VOLTAGE RELAY 3ph 3NAC	VMD420-D-1	B93010005	B73010005
	VMD420-D-2	B93010006	B73010006
	VMD421H-D-3	B93010007	B73010007
VOLTAGE RELAY 1ph AC/DC	VME420-D-1	B93010001	B73010001
	VME420-D-2	B93010002	B73010002
	VME421H-D-1	B93010003	B73010003
	VME421H-D-2	B93010004	B73010004

Options M, M1C, M2C and M3C on request.

**Technical data**
**Switching elements**

Number of changeover contacts, standard:	2 x 1 changeover contacts				
Electrical service life under rated operating conditions	10.000 switching operations				
Contact data acc. to IEC 60947-5-1					
Utilization category	AC-13	AC-14	DC-12	DC-12	DC-12
Rated operational voltage	230 V	230 V	24 V	110 V	220 V
Rated operational current	5 A	3 A	1 A	0,2 A	0.1 A
Minimum contact load	1 mA at AC / DC > 10 V				

**General data**

Max. no load voltage (terminals open)	DC 20 V
Max. short-circuit current	30 mA short-circuit proof
Voltage output	DC 0...10 V
Load min.	1 k $\Omega$
Current output	DC 0/4...20 mA
Load max.	500 $\Omega$
Current output	DC 0...400 $\mu$ A
Load max.	12.5 k $\Omega$

( ) \* factory setting

### Current output 0/4...20 mA

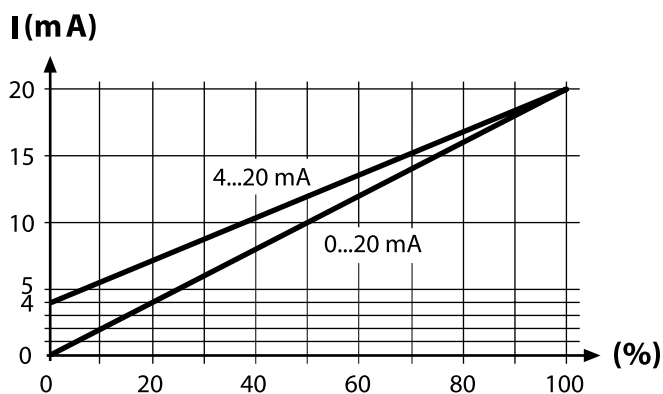

### Voltage output 0...10 V

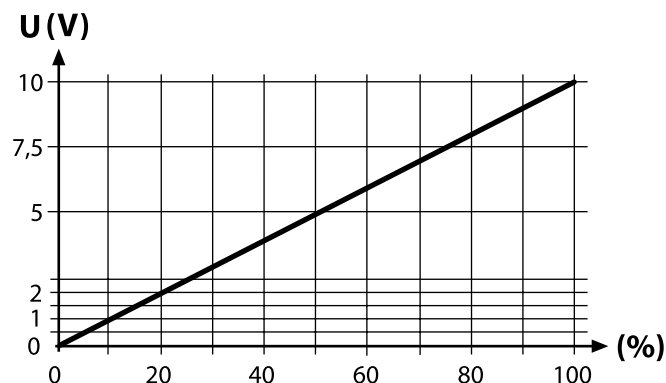

### Current output 0...400 $\mu$ A

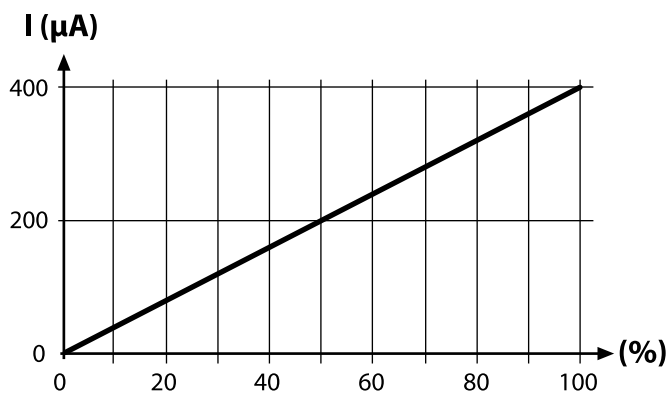

#### Note:

A free configurable value ( $I$ ,  $U$ ,  $I_{\Delta n}$ ,  $A_{sy}$ ) or the response value of the respective device can be set as 100% value via the menu.

This does not apply to insulation monitoring devices.

The characteristic curves for the insulation resistance  $R_F$  can be found in the respective manual of the insulation monitoring device.



#### Bender GmbH & Co. KG

P.O. Box 1161 • 35301 Grünberg • Germany  
Londorfer Strasse 65 • 35305 Grünberg • Germany  
Tel.: +49 6401 807-0 • Fax: +49 6401 807-259  
E-Mail: info@bender.de • www.bender.de



BENDER Group