



COMTRAXX® CP305 - Control Panel

Remote alarm indicator for medical locations and other areas
Software version 1.5.x



Table of contents

1	General information.....	6
1.1	How to use the manual.....	6
1.2	Indication of important instructions and information.....	6
1.3	Service and Support.....	6
1.4	Training courses and seminars.....	6
1.5	Delivery conditions.....	6
1.6	Inspection, transport and storage.....	7
1.7	Warranty and liability.....	7
1.8	Disposal of Bender devices.....	7
1.9	Safety.....	8
2	Product description.....	9
2.1	Intended use.....	9
2.2	Scope of delivery.....	9
2.3	Device features.....	10
2.4	System description.....	11
2.5	Interfaces.....	13
3	Mounting.....	15
3.1	Dimension diagram CP305.....	15
3.2	Flush-mounting.....	15
3.3	Surface mounting.....	18
3.4	Retrofit: Replacement of MK2430.....	19
4	Connection.....	20
4.1	Safety instructions.....	20
4.2	Notes on the connection.....	21
4.3	Connection diagram.....	22
4.4	Ethernet connection.....	24
4.5	Digital inputs and relay outputs.....	25

5	Commissioning.....	27
6	Software update.....	29
7	Factory settings for communication.....	30
8	Display and operation.....	31
9	Display CP305: Menu structure.....	33
9.1	Measured values.....	33
9.2	Bus overview.....	33
9.3	History.....	33
9.4	Alarm and test.....	35
9.5	Settings.....	36
9.6	Info.....	40
10	Web user interface: menu structure (via ETH socket).....	41
10.1	COMTRAXX® user interface.....	41
10.1.1	Header.....	41
10.1.2	Navigation.....	42
10.1.3	Subnavigation.....	42
10.1.4	Content section.....	42
10.1.5	Alarm overview (footer).....	43
10.2	Start.....	43
10.3	System overview.....	43
10.3.1	Device tools.....	43
10.3.2	Menu.....	44
10.3.3	BMS.....	44
10.3.4	Modbus RTU.....	44
10.4	Alarm overview (footer).....	44
10.5	Tools.....	45
10.5.1	Monitoring.....	45
10.5.2	Device management.....	49
10.5.3	Service.....	50
10.5.4	Information.....	51
11	Web user interface: Menu structure (access via gateway).....	52
11.1	Device tools.....	52
11.2	Menu.....	52
11.2.1	Edit texts.....	52
11.2.2	Info.....	53

12	Export and import of device data.....	54
13	Cleaning, servicing and troubleshooting.....	55
13.1	Cleaning.....	55
13.2	Servicing.....	55
13.3	Error messages.....	55
13.4	LED.....	55
13.5	Malfunctions.....	56
13.6	Recurring inspections.....	56
14	Technical data.....	58
14.1	Tabular data.....	58
14.2	Standards and approvals.....	63
14.3	Ordering information.....	63
14.4	EU Declaration of Conformity.....	63
14.5	Documentation revision history.....	64

1 General information

1.1 How to use the manual



NOTE

This manual is intended for qualified personnel working in electrical engineering and electronics! Part of the device documentation in addition to this manual is the enclosed supplement "Safety instructions for Bender products".



NOTE

Read the operating manual before mounting, connecting and commissioning the device. Keep the manual within easy reach for future reference.

1.2 Indication of important instructions and information



DANGER

Indicates a high risk of danger that will result in death or serious injury if not avoided.



WARNING

Indicates a medium risk of danger that can lead to death or serious injury if not avoided.



CAUTION

Indicates a low-level risk that can result in minor or moderate injury or damage to property if not avoided.



NOTE

Indicates important facts that do not result in immediate injuries. They can lead to malfunctions if the device is handled incorrectly.



Information can help to optimise the use of the product.

1.3 Service and Support

Information and contact details about customer service, repair service or field service for Bender devices are available on the following website: Fast assistance | Bender GmbH & Co. KG.

1.4 Training courses and seminars

Regular face-to-face or online seminars for customers and other interested parties:

www.bender.de > know-how > seminars.

1.5 Delivery conditions

The conditions of sale and delivery set out by Bender GmbH & Co. KG apply. These can be obtained in printed or electronic format.

1.6 Inspection, transport and storage

Check the shipping and device packaging for transport damage and scope of delivery. In the event of complaints, the company must be notified immediately, see "www.bender.de > service & support."

When storing the devices, observe the information under Environment / EMC in the technical data.

1.7 Warranty and liability

Warranty and liability claims for personal injury and property damage are excluded in the case of:

- Improper use of the device.
- Incorrect mounting, commissioning, operation and maintenance of the device.
- Failure to observe the instructions in this operating manual regarding transport, commissioning, operation and maintenance of the device.
- Unauthorised changes to the device made by parties other than the manufacturer.
- Non-observance of technical data.
- Repairs carried out incorrectly.
- The use of accessories or spare parts that are not provided, approved or recommended by the manufacturer.
- Catastrophes caused by external influences and force majeure.
- Mounting and installation with device combinations not approved or recommended by the manufacturer.

This operating manual and the enclosed safety instructions must be observed by all persons working with the device. Furthermore, the rules and regulations that apply for accident prevention at the place of use must be observed.

1.8 Disposal of Bender devices

Abide by the national regulations and laws governing the disposal of this device.



Bender GmbH & Co. KG is registered in the waste from electrical and electronic equipment (WEEE) register under the WEEE number: DE 43 124 402. For more information on the disposal of Bender devices, refer to www.bender.de > service & support.

1.9 Safety

If the device is used outside the Federal Republic of Germany, the applicable local standards and regulations must be complied with. In Europe, the European standard EN 50110 applies.



DANGER Risk of fatal injury due to electric shock!

Touching live parts of the system carries the risk of:

- Risk of electrocution due to electric shock
- Damage to the electrical installation
- Destruction of the device

Before installing the device and before working on its connections, make sure that the installation has been de-energised. The rules for working on electrical systems must be observed.

2 Product description

2.1 Intended use

The COMTRAXX® CP305 control panel is for visual and acoustic signalling of operating and alarm messages from the Bender systems MEDICS®, ATICS®, EDS and RCMS. In MEDICS® monitoring systems, the CP305 fulfils the requirements of the standard DIN VDE 0100-710 concerning test functions for IT system monitoring and messaging from changeover devices. Testing of the IT system monitoring equipment is carried out via the test button and the devices to be tested.

Important display functions

- Normal operation indicator
- Insulation fault
- Overload
- Overtemperature
- Interruption of the ISOMETER® mains or protective earth connection
- Supply line failure
- Power supply fault conditions and changeover device faults
- Device failure
- Test results
- Measured values

The connection between the CP305 and the transfer switching and monitoring modules is implemented with bus technology. During normal operation, the CP305 indicates the readiness for operation of the system.

The CP305 has 12 digital inputs with which messages from other systems can be received and displayed on the CP305, for example those dealing with medical gases or battery-supported central power supply systems (CBS equipment).

Two relay contacts make it possible to pass messages to the higher-order building management system. The relay contacts can also be used as switches that can be operated via the display.

CP305 devices are used in

- Healthcare facilities
- Industrial and office buildings
- Public buildings

Please heed the limits of the area of application indicated in the technical specifications.

Operator control and adjustment of settings is partly done directly on the device or in a web browser.

Any other use than that described in this manual is regarded as improper.

Intended use includes:

- Equipment-specific settings compliant with local equipment and operating conditions
- Observation of all information in the operating manual
- Compliance with test intervals

2.2 Scope of delivery

You get

- Remote alarm indicator CP305
- Connection plug kit (power supply, RS-485 connection)
- Connections for the digital inputs and relay outputs

- A printed quick reference guide
The manuals are available at: <https://www.bender.de/en/service-support/download-area/>
- Safety instructions for Bender products

Installation options

- Flush-mounting (flush-mounting enclosure B923710)
- Surface mounting (surface-mounting enclosure B95100153)
- Cavity wall mounting (cavity wall mounting kit B923711)
- Panel mounting (flush-mounting enclosure B923710 and mounting kit B95101000)
- DIN rail mounting (flush-mounting enclosure B923710 and mounting kit B95101000)
- Retrofit (CP305 can be inserted directly into existing MK2430 flush-mounting enclosure; other devices on request)

2.3 Device features

Properties

The CP305 display shows the messages from all RS-485 bus participants that have been allocated to it via alarm addresses. This means that a CP305 can be used not only as an individual display, but several CP305s can also be employed as parallel displays in different rooms.

The alarm colours for the LEDs are configurable (e.g. red for an alarm, yellow for a warning, such as an insulation fault or the like).

In addition to the LED, there is also an alarm pop-up (display) as well as an entry in the alarm overview (web user interface) when a message occurs. An acoustic signal sounds, for which the parameters can also be configured (can be acknowledged / muted).

If an additional message occurs while an existing message is pending, the acoustic signal sounds again and the messages are shown alternately on the display. Moreover, the address of the device that has triggered the alarm can be displayed. The acoustic signal is repeated after a configurable time (the repetition can also be switched off).

The menu system allows access to internal device parameters (alarm addresses, test addresses, etc.). Individual note texts can be configured for each alarm and test address. The CP305 can be employed as the master in systems consisting of several IT and EDS systems.

The "TEST" button can be used to check the function of the associated devices, such as insulation monitoring devices, LIM (Line Isolation Monitors) or GFCI (Ground Fault Circuit Interrupters). A message appears only on the CP305 on which the test was started. The test and its individual evaluations run sequentially. Afterwards, a message concerning the successful test or a fault message is output.

In bus networks (BMS) with more than one master-capable device, one CP305 used as a backup master is able to maintain the functionality of the bus communication.

CP305 devices have the following properties:

- Display of operating, warning, and alarm messages according to DIN VDE 0100-710, IEC 60364-7-710 and other standards
- 12 digital inputs
- 2 relay contacts (changeover contacts) that can also be operated using a switch on the display
- Plaintext display with backlight 5" touch display
- Easy to clean and disinfect, degree of protection IP54 (overall device) and IP66 (front glass panel)
- Front glass panel mounted without screws

- User-friendly, touch-sensitive monitoring system for medical uses and other applications
- Exceptionally simple user guidance
- Additional information for medical and technical personnel
- Visual and acoustic signalling in the event of an alarm
- Clear menu structure
- Silent due to fanless operation
- High-quality visualization with outstanding contrast, high resolution and a wide viewing angle
- Device testing and modification of the parameter settings with minimal service interruptions
- Standard texts for messages can be selected in the national language
- 2 languages can be configured and switching between them is possible during operation
- 500 freely programmable message texts
- Bus technology for simple installation and low fire load
- Acoustic alarm can be acknowledged / muted
- Versions for flush mounting and surface mounting
- Predefined message texts simplify start-up
- History memory with real time clock for storing 1000 warning and alarm messages
- Voltage supply via power supply unit
- Parameter configuration via Ethernet interface
- NFC interface for connecting to the Bender Connect App
- Replace MK2430 (retrofit); other devices on request

Applications

- Visualisation on the display optimally tailored to the user
- Integration of all compatible Bender products (MEDICS®, ATICS®, EDS, Linetraxx® RCMS systems and ISOMETER®)
- Individual instructions for action in the event of alarms

2.4 System description

Certification

COMTRAXX® CP305 are UL certified.

MEDICS®

The CP305 remote alarm indicators are components of the MEDICS® systems. MEDICS® is an intelligent system that guarantees safe power supply in medical locations.

Connection example BMS

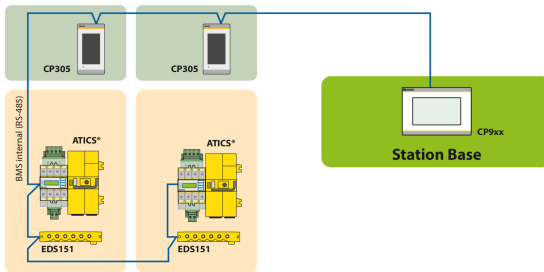

In the example, the ICU is monitored from the station base via BMS bus.

Connection example BMS and Ethernet

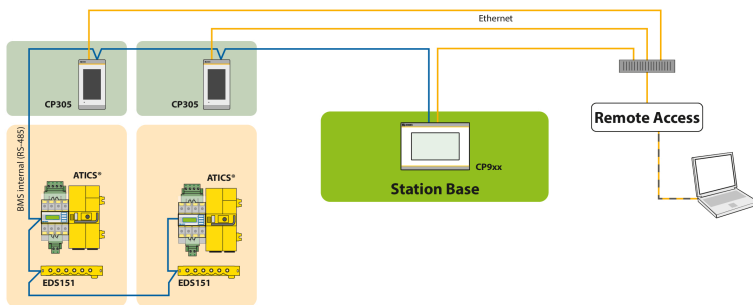

In the example, the ICU can be monitored from the station base. In addition, remote maintenance is possible via the building services or Bender.

i For safe operation of the Medics® system in accordance with IEC 60364-7-710 and IEC 61557-8, we recommend operating the self-monitoring system with a second master-capable device from the Control Panel family.

Connection example for Modbus RTU and Ethernet

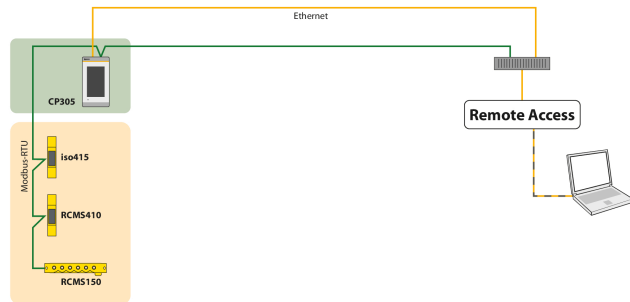

In the example, remote maintenance via the building services or by Bender is possible.

2.5 Interfaces

RS-485

The RS-485 interface can be configured as a BMS bus or as a Modbus RTU interface with additional Bender Smart-Connect properties.

i A CP305 can only belong to one RS-485 bus (BMS **or** Modbus RTU). Parallel operation of both protocols is not possible.

Terminating resistor

Correct termination is fundamentally important for trouble-free operation of the CP305. The respective first and last device on the bus must be terminated with a terminating resistor (daisy chain). If the CP305 needs to be terminated, the terminating resistor can be switched in using a DIP switch on the bottom of the device.

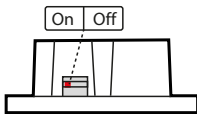

DIP switch on the bottom

Addressing

Trouble-free operation of the CP305 requires that it be addressed correctly.

BMS

- The BMS bus is used for communication with the BMS-bus devices or devices such as RCMS..., EDS..., SMI..., SMO..., ATICS®, signalling and control panels.
- CP305 is the master when the address is set to 1. When the address is set to 2...90, the CP305 is a slave. The master controls the data traffic on the BMS bus.

i The CP305 should be operated as a master if

- Parameters are queried or changed;
- Certain control commands are issued.

- The CP305 has a backup master function. If the master on the BMS bus drops out, a CP305 in the address range of 2...90 assumes the master function.
- Measured values and alarms can be visualized on different CP305s on the BMS bus.



The BMS bus offers the following properties:

- Auto-detection of devices, login and creation of measuring channels
- Cyclical query of measured values and errors

Modbus RTU (with Bender Smart-Connect properties)

- Modbus RTU is used for communication with Bender devices such as RCMS410 or iso415.
- CP305 is always the master (address 1). The master controls the data traffic on the bus.



The Modbus RTU with Bender Smart Connect offers the following properties:

- Auto-detection of devices, login and creation of measuring channels
- Cyclical query of measured values and errors
- Device menus and device parameter configuration via the display device or the web application
- Address changes via the operating device
- Device search in the switchboard cabinet (blinking LEDs)

Ethernet

The CP305 can be addressed over the Ethernet using the RJ45 interface "ETH". The web server required for this is contained in the device. The configured IP address can be found on the device under  > Info.

The web user interface can be used to adjust all device settings.

NFC (near-field communication)

The energized device can also be parametrized via NFC. The interface can be activated on the CP305 under  > Settings > Interface > NFC. After this, the configuration that has been prepared can be loaded to the device via the Bender Connect App.

3 Mounting

3.1 Dimension diagram CP305

All dimensions are in mm.

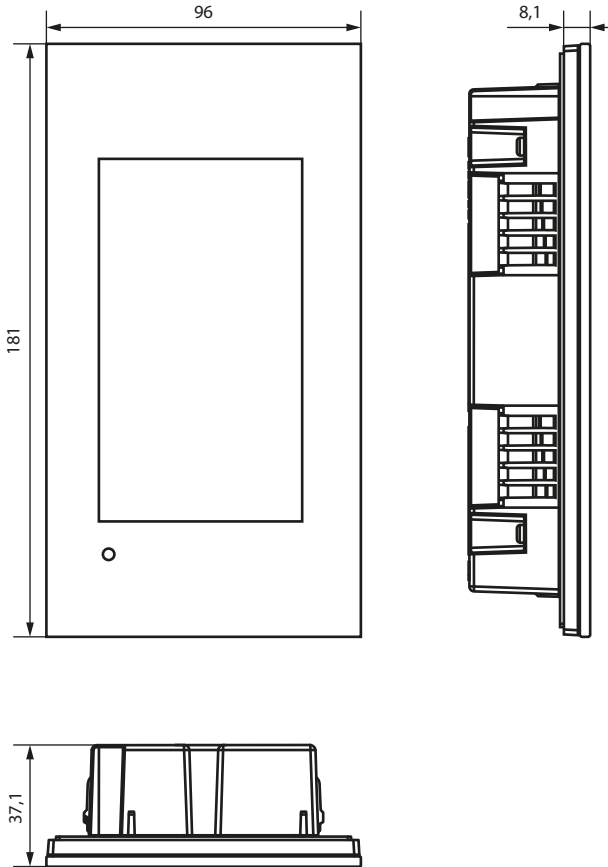

3.2 Flush-mounting



The flush-mounting enclosure is optionally available (B923710).

Dimension diagram flush-mounting enclosure

All dimensions are in mm.

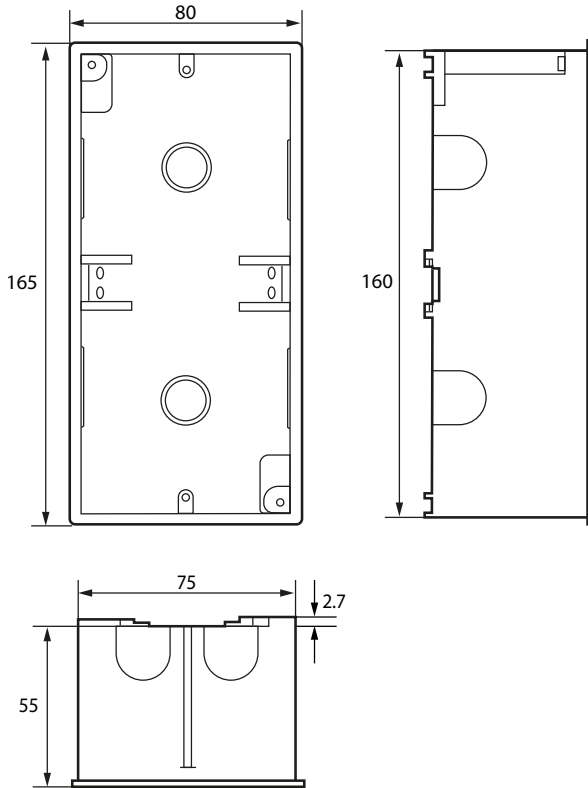

Installation of flush-mounting enclosure

1. Insert the supplied cardboard into the flush-mounting enclosure to provide protection against pollution.
2. Insert the enclosure so that it is flush with the wall surface.

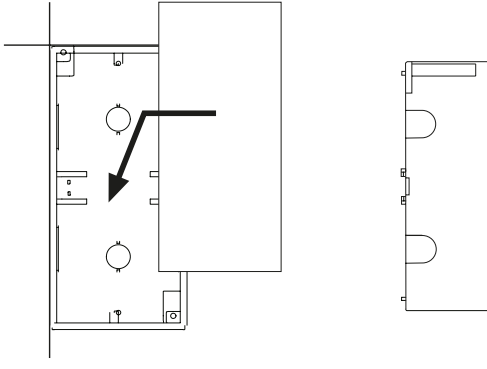

The flush-mounting enclosure must not be installed lopsidedly or warped, and must not be installed too deep below the surface.

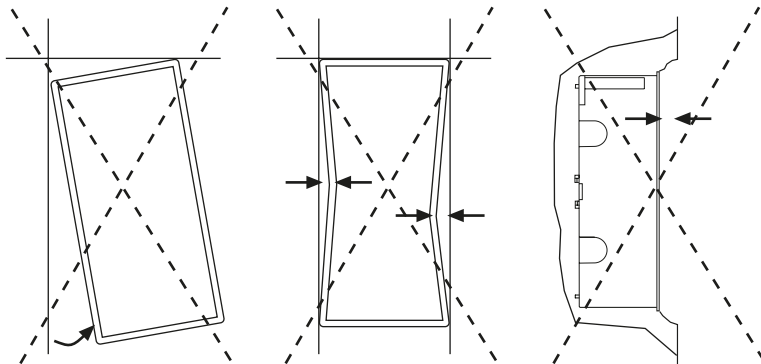

3.3 Surface mounting

Surface mounting requires use of the appropriate surface-mounting enclosure (part. no. B95100153).

All dimensions are in mm.

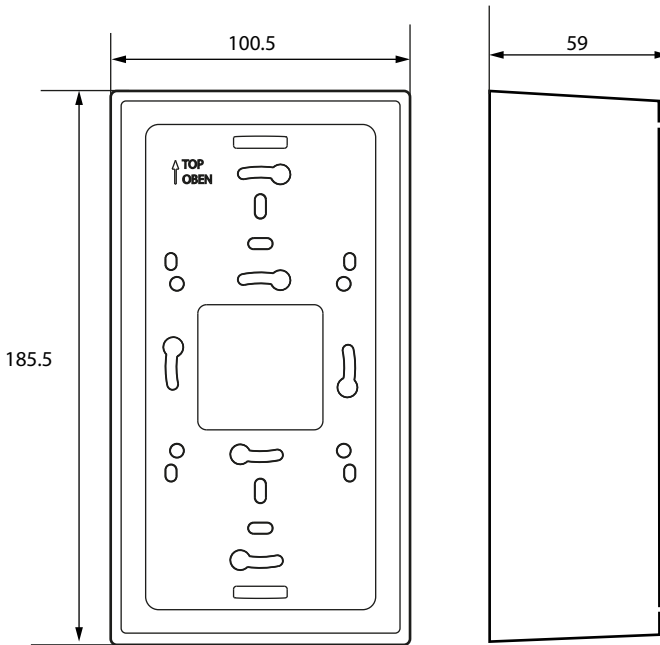

i Any clearance between the surface-mounting enclosure and the wall must be compensated using washers. Never tighten the screws with a cordless screwdriver; only do so by hand. If this is disregarded, the surface-mounted housing can become warped.

Cavity wall and panel mounting

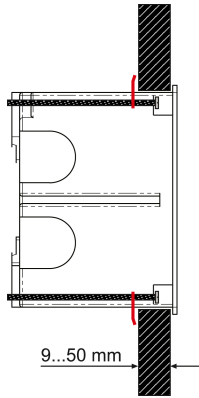

**Cavity wall
mounting**

Mounting kit required

B923711

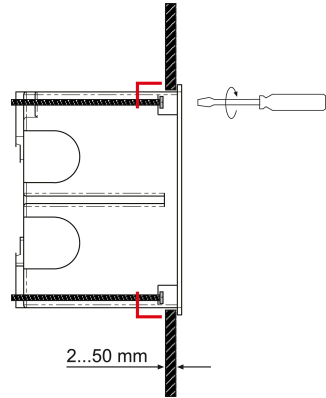

Panel mounting

B95101000

3.4 Retrofit: Replacement of MK2430

In the context of retrofit measures, CP305 can be installed directly in the existing flush-mounting MK2430 enclosures.

i *If MK2418, MK2410 or other devices are to be replaced, the flush-mounting enclosures must be changed. Please contact Bender Service for details.*

4 Connection

4.1 Safety instructions



Only skilled persons are permitted to carry out the work necessary to install, put into service and run a device or system.



DANGER Danger of electric shock!

Follow the basic safety rules when working with electricity. Observe the information on rated voltage and supply voltage specified in the technical data!



CAUTION

Electrostatic discharge sensitive devices

Observe the precautions for handling electrostatically sensitive devices.

Damage to components

Do not remove the device from the enclosure while it is in operation. Disconnect the device from the power supply and the network (Ethernet) beforehand.

Damage to the device due to incorrect connection plug

Connectors of other devices may have polarity that differs. You are required to use the enclosed connector plug (A1/+, A2/-).

Safe separation

The power supply must be properly insulated from hazardous voltages and meet the limits of UL/CSA 6101010-1 (6.3).



NOTE

Connect the CP305 exclusively according to the connection diagram in this chapter. Do not make any changes to the internal wiring.

Non-compliant connection or arbitrary changes can lead to serious malfunctions or even complete failure of the CP305.



To comply with the requirements of DIN VDE 0100-710, AC power supplies with max. 25 VAC must be used.



All enclosed connectors should always be plugged in even when they are not in use.

PELV

If a DC power supply unit is used to supply one or more CP305 devices, A2/- can be connected to protective earth. **Then shielded Ethernet cables can also be used.**

SELV

If an AC or DC power supply without a secondary connection between A2/- and protective earth is used to supply one or more CP305 devices, **unshielded Ethernet cables must be used.**

4.2 Notes on the connection

Supply voltage

Connect the CP305 to the supply voltage (terminals A1/+, A2/-).

- **DC 24 V:** Take the line voltage drop into account if you are using long supply cables for the supply voltage. Consider the maximum permissible cable lengths for the supply voltage (A1/+, A2/-) (see "Technical data").
- The DC power port is not intended for a connection to a public DC supply network.

Ethernet

- The currently configured IP address can be read out in the device under  > Info. The IP address for a 1:1 connection is unique for each device and derived from the MAC address when the device is started.

RS-485

- The **BMS** (Bender measuring device interface) and **Modbus-RTU** protocols can be operated on the RS-485 interface.
- The connection is established via terminals RS-485 A / RS-485 B.
- Use a shielded and twisted cable with a diameter of at least 0.8 mm for the interface line (e.g. CAT6/CAT7 min. AWG23). Connect the shield to earth at one end. Please note that when routing the supply voltage U_{ζ} , a 4-wire cable (2 x BUS, 2 x U_{ζ}) with suitable cross section is required.
- The first and last device on the bus must be terminated with a terminating resistor. Use the DIP switch on the bottom of the CP305 to set the terminating resistor for the bus (factory setting: off).
- Further information on the BMS bus can be found in manual D00276.

Digital inputs/relay outputs

- Use cables with a cross section of at least 0.75 mm² when connecting the digital inputs and the relay outputs.
- The maximum cable length per connection is 500 m.

4.3 Connection diagram

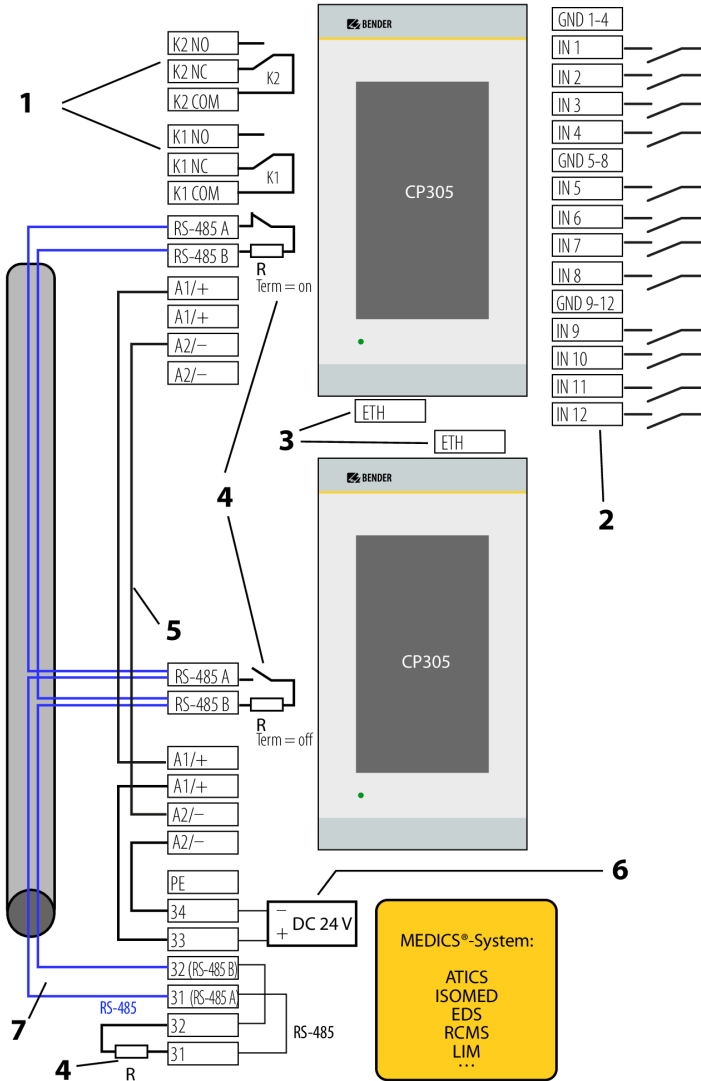

Legend for the connection diagram

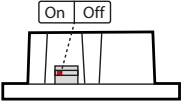
No.	Terminal	Explanation	
1	K...COM K...NC K...NO	2 relay outputs Parametrisable contacts for device errors, test of assigned devices**, device failure and common alarm message.	
2	IN1...12 GND...	Digital inputs The digital inputs are divided into three groups of four, which are galvanically separated from each other and from the device. Each group has its own GND terminal for the reference potential. If the inputs are controlled via an external voltage, the common reference potential is connected to the "GND" terminal and the signal is connected to the respective input IN1...12.	
3	ETH	Ethernet interface for connection of a PC The CP305 can be integrated into the Bender/hospital network via the Ethernet interface. Parameters can be set on the PC, and data as well as the history memory can be read out. Connected measuring devices can be displayed with their channels.	
4	R	Terminating resistor of RS-485 interface If two or more devices are connected to each other via RS-485, the bus line must be terminated at both ends with a resistor ($R = 120 \Omega$) (can be switched on via dip switch on the underside of the CP305).	
5	A1+/A2- ~	Supply voltage Adhere to the permissible cable lengths and cross sections when supplying the CP305 in the MEDICS® modules.	
6	DC 24 V	power supply unit in the MEDICS® module, sufficient for supplying power to up to two CP305 devices.	
7	RS-485 A RS-485 B	BMS bus connection (see also D00276) oder BSC-RTU bus connection Cable: Shielded, one end of shield connected to PE Recommended CAT6/CAT7 min. AWG23 Alternatively Cable, twisted pairs, J-Y(St)Y min. 2x0.8 Connect shield to PE on one side Various Bender devices with a BMS bus interface. Examples: ATICS, ISOMED427P, EDS151, RCMS..., CP9xx, ... Various Bender devices with a BSC-RTU bus interface. Examples: LIM...	

** Devices without BMS bus connection, but with test input (e.g ISOMETER®)

Connection assignment (rear)

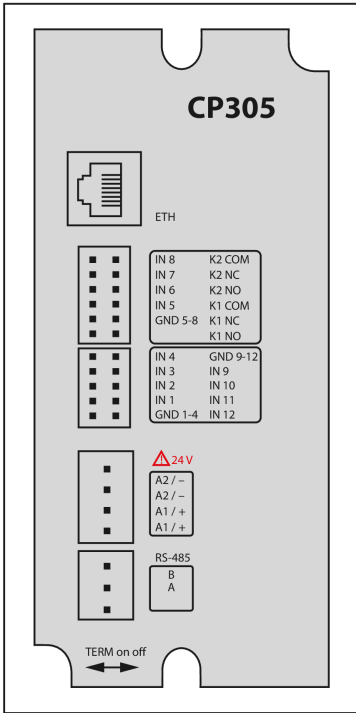

The connections are located on the back of the device.

The dip switch for terminating the RS-485 bus is located on the bottom of the device:

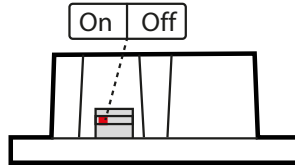

4.4 Ethernet connection

An RJ45 socket insert and a Cat.6 SLIM patch cable are included in the connector kit (item no. B95100152).

i The CP305 can be connected with a standard RJ45 cable with a rigid connector only via the connector kit.

4.5 Digital inputs and relay outputs



NOTE

This equipment is not intended for use in residential environments and may not provide adequate protection to radio reception in such environments.

(Non-domestic environment, CISPR 11:2015/AMD1:2016/AMD2:2019, Group 1, Class A; IEC 61000-6-4:2018-02 Ed. 3.0)

CP305 devices have 12 digital inputs (DI) for which parameters can be set and 2 relay outputs for which parameters can be set. The settings are made in a browser using the web user interface.



CAUTION

The digital inputs and relay outputs must not be connected directly to the power supply network or to the power supply unit that supplies the CP305.

Use a separate, galvanically isolated power supply unit!

Operating mode digital inputs

The choices are “off”, “High-active”, “Low-active”.

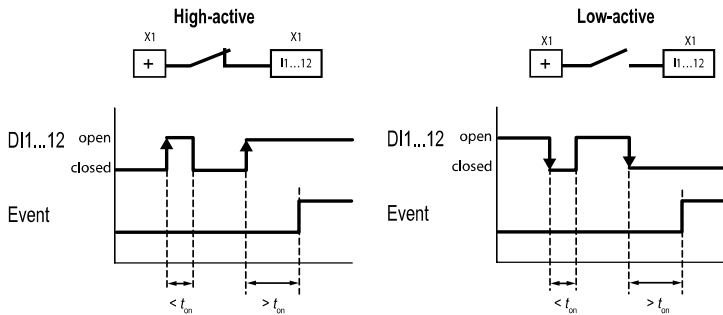

High-active (N/C)

An event is executed when the digital input experiences an edge change from low to high. Response time t_{on}/t_{off} after a switch-on signal.

Low-active (N/O)

An event is executed when the digital input experiences an edge change from high to low. Response time t_{on}/t_{off} after a switch-off signal.

Response times t_{on}/t_{off}

- on The response time t_{on} after a switch-on signal can be adjusted from 0 ms ... 10 minutes
- off The response time t_{off} after a switch-on signal can be adjusted from 0 ms ... 10 minutes

Relay

CP305 has 2 relay outputs (changeover contacts K1 and K2) for which parameters can be set. They can be used to forward error, test or (collective) alarm messages to a building management system.



The relay contacts can also be used as switches that are operated via the display.

Data traffic via Modbus TCP

The 12 digital inputs as well as the 2 relays can be accessed via Modbus TCP.

Register	Property	Format	Description
4096	RO	UINT16	Output of the digital inputs IN1...12 as bit mask
4097	RO	UINT16	Digital input IN1
4098	RO	UINT16	Digital input IN2
...			
4108	RO	UINT16	Digital input IN12
4109...4111			Reserved
4112	RO	UINT16	Output of both relays as a bit mask
4113	RO	UINT16	Relay K1
4114	RO	UINT16	Relay K2

5 Commissioning

Commissioning assistant

During initial putting into service or after a reset to factory settings, the putting-into-service wizard opens for the basic setup steps.

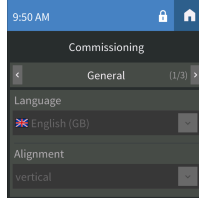

The putting-into-service wizard launches in English. The header is blue, and the LED is blue.

You need to log in to the device (with the PIN via the  icon in the header). Only then are changes possible. Use the drop down menus to change entries. Changes are confirmed (green) or discarded (red) at the top of the display.

You can exit the putting-into-service wizard at any time if you click the  icon in the header. Changes that have already been made are not discarded.

i *Address settings:*
 If several parameters can be changed in one box, first touch one of the positions. This is now highlighted in white and can be set to the correct value with the arrow keys. Repeat these steps until the parameters are correctly set for the address.

Changes are confirmed (green) or discarded (red) at the top of the display.

The following basic settings are requested and can be set:

General

- Language
- Alignment

RS-485

Protocol BMS

- Address (1 = Master)
- Intervall
- Acknowledgement via interface

Protocol Modbus-RTU

- Baud rate
- Parity
- Stop bits
- Alarm query interval

Ethernet

- Protocol (HTTP|HTTPS)
- DHCP (on|off)

- IP address (DHCP)

The IP address that is currently set is displayed.

"Complete" sets up the device.

i *If no test or alarm addresses have been set up, you will receive a message to this effect. You can use the web user interface to configure these addresses.*

You can configure additional settings on the display or the web user interface on the PC. For details on alarm addresses, see section "Edit alarm address", Page 46.

NFC (near-field communication)

The powered device can also have its parameters set via NFC. The interface is activated on the CP305 under  > Settings > Interface > NFC. Afterwards, the prepared configuration can be loaded onto the device using the Bender Connect app.

Electromagnetic disturbances may affect the NFC dialog between the CP305 and an external NFC transceiver.



The NFC interface can be used to transmit a previously configured device parameter setting directly to the device.

i *This function is available only via the Bender Connect App. You can find this app in the Appstores for iOS and Android.*



In the Bender Connect app the device first needs to be made known. Then the device-specific setting options are shown so that they can be configured. When the data is transferred, feedback is given whether the parameter configuration has been successful. Parameter settings can be transmitted to the device via the Bender Connect app by holding the mobile phone close to the device.



To a **de-energised** device, a parameter setting can be transferred via the Bender Connect app. This setting is then activated automatically when the device is connected to the current supply.



When a device is **plugged in**, too, parameters can be configured via the Bender Connect App. To this end, the NFC interface first needs to be activated in the device.

6 Software update

The CP305 software is continuously being developed. To use the latest software on your device, you have the option of updating your device regularly.

i *It is recommended to create a backup before an update.*

Download the current software version from the Bender homepage and save it to your PC. Now connect the CP305 to the PC.

i *The parameterised IP address of the CP305 can be found in the device menu under Info.*

You will find the update option in the navigation in the web browser under  Tools > Service > Update. Follow the individual steps.

Update to V1.5.x

A direct update to software version V1.5.x is possible from version **V1.0.9**. If your device is still using an older version, first update it to V1.0.9 and then to V1.5.x.

If you did not perform the step with the intermediate version V1.0.9 during the update, you must restart the CP305 once. You can now install the V1.0.9 update first and then V1.5.x.

i ***When updating the software version from V1.0.9 to V1.5.x, the following behaviour occurs:***

The web application reports that the update did not work. This is because HTTPS is activated by default from version V1.5.x and the gateway no longer responds to HTTP after the update. Therefore, it looks to the web application as if the update did not work.

Reloading the page fixes the message.

7 Factory settings for communication

The settings can be changed on the device or via the web user interface.

Parameter	Explanation
IP address	
IP address for 1:1 ETH connection	Address range (169.254.xx.yy) Note: xx and yy are derived from the MAC address during putting into service and are therefore unique for each CP305. This address cannot be changed.
Netmask	255.255.255.0
Standard gateway	192.168.0.1
DNS	192.168.0.1
DHCP	on
BMS address	1
RS-485	BMS with - Address 1, - Interval 2 - Acknowledgement via interface On
Protocol	HTTPS

8 Display and operation

i Operation with latex, vinyl or nitrile gloves is possible with no restriction in functionality.

LED and display

Display in **normal operation**: No warning or alarm messages are pending.

- The LED is illuminated green.
- The display shows the programmed standard display (start page).

i The start page can be configured in the web operating application:
 **Tools > Device management > Start page**



Display when warning or alarm messages are pending





- The LED is illuminated blue when no alarm address has been entered. This is also indicated by a message on the display.
- The LED is illuminated blue when the buzzer has been muted.
- If there is an alarm, the LED is illuminated red or in the colour that has been assigned to the alarm.
- Depending on the type of error, the display is either yellow ("Warning") or red ("Alarm"). At the same time, a buzzer sounds. If the cause cannot be rectified right away, it is possible to mute the buzzer tone using the "Acknowledge" button.
- Depending on the type of error, the display has the colour that has been assigned to the alarm. At the same time, a buzzer sounds (if this has been configured). If the cause cannot be rectified right away, it is possible to mute the buzzer tone for the time period that has been configured using the "Acknowledge" button.
- The display shows information about the message. The message remains visible until rectification has been completed.
- If there are several messages simultaneously, they are displayed alternately. The LED then has the colour of the alarm with the highest priority (priority 10 is higher than priority 5).

i If there are several alarms pending, you can swipe through the messages on the right of the display (gesture control).

Header



i The icons in the header can be clicked on. This shows the details directly or the display language can be changed (if configured).

Element	Meaning	Note
Time		The current time is displayed on the left automatically. i If the device is muted, a message is displayed showing for how long the buzzer is disabled instead of the time.
	NFC logo	The NFC logo is only shown when the NFC interface has been enabled.
	Not logged in	

Element	Meaning	Note
	Logged in	Enter PIN or PIN disabled
	Menu	If you are not logged in to the device as an administrator, you can only display the menu items, but cannot change or set them. For details, see "Display CP305: Menu structure", Page 33.
Country flag	Second display language	Clicking on the country flag switches the display to the second display language that has been set. Automatic changeover has been implemented for many texts. i <i>The freely formulated texts on the start page can currently only be monolingual.</i> i <i>Action instructions must already be created in the respective languages and assigned to them when they are created (in the web application). This is the only way they can be displayed when the language is changed.</i>
	Pending alarms	There are alarms pending that have been suppressed in the alarm overview using the X in the header. The number in the circle indicates the quantity of current messages.
	Device muted	i <i>This setting is for commissioning. It does not satisfy the requirements of the standards for acoustic alarming.</i>

Footer

i *The icons in the footer can be clicked on.*

Element	Meaning	Note
	Stopwatch	A stopwatch can be started in the standard display. The time measurement can be interrupted. After the interruption, the time measurement can be resumed or reset. Range (24 h - 1 s) Step size, 1 s
	Timer	A timer can be set and started in the standard display. It counts down to 0 and indicates that the time interval has elapsed by means of a buzzer. The timer can be paused and also be reset. The timer buzzer can be interrupted ("Mute" button). Setting range: 1 s... (10 h-1 s) Step size, 1 s
	Cleaning	The display can be locked for user input for 5...20 seconds (configurable) to permit the prescribed cleaning.
TEST		If at least one test address has been created (via the web user interface), the button for starting the test appears.

9 Display CP305: Menu structure



*Normal state: The header and the LED are green when there is no alarm.
In the event of an alarm, the header and LED take on the colour of the highest alarm level present.*

9.1 Measured values

The overview shows measured values and current statuses of digital inputs 1...12 and relays 1...2.



If service inspections are configured, the next service is indicated at this point.

9.2 Bus overview

Touching a device in the bus overview takes you to its detail page. Depending on the device, the individual channels, their alarm status and the current measured values are listed here.

BMS

The bus overview shows the BMS bus addresses used with the connected devices. Because of the BMS bus cycle, it may take some time until all bus addresses are updated.



In the web browser, this information is available in the system overview.

Modbus-RTU

The bus overview shows the Modbus-RTU bus addresses used with the connected devices.

9.3 History

The warning and alarms are automatically stored in the history memory with dates and timestamps. 1000 text messages can be stored.

Each subsequent message overwrites the oldest message (message 1001 overwrites message 1 and so on).

Each entry in the list opens a pop-up with further information when touched.



*The history can also be found in the web user interface.
Header > System > Menu ≡ > History*

Detail pop-up of an entry in the history

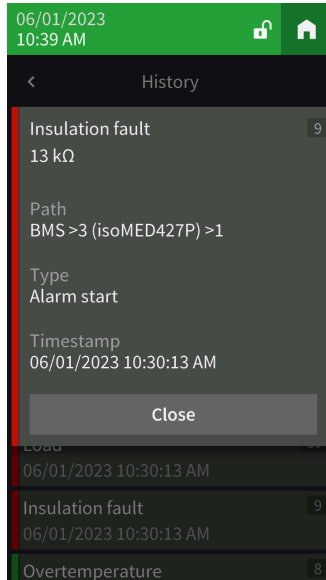

Element	Comments
Error category	Messages that come up are indicated in different colours, depending on their type, both on the display and in the stored history. Warnings: yellow Alarms: red Warning end, alarm end: green
Error designation	Device error DHCP error Digital input Voltage dips Insulation fault search Overtemperature Load Insulation fault Failure address
Number of the error message in the history	
Path specification	Address where the error occurred
Type	Alarm start, alarm end, error, device restart
Time stamp	Occurrence and end of the error

9.4 Alarm and test

Alarm addresses

Display of the addresses/measuring channels whose alarm messages are assigned to the CP305.

The alarm addresses are configured in the web user interface.

Menu item	Entry	Setting range/values
1/6 General	Path	
	Priority	0...255
	Repetition interval	0...60 minutes
	Active on prewarning	On Off
	Active on test	On Off
	Select alarm colour automatically	On Off
	Alarm colour	
	Alarm group	
2/6 Dialog	Image	
	Show alarm group	On Off
	Show device description	On Off
	Show individual device description	On Off
	Show individual alarm text	On Off
	Show channel description of the measuring point	On Off
	Show individual text of the measuring point	On Off
	Show measured value	On Off
	Show path	On Off
3/6 Instruction	Show instruction	On Off
4/6 Alarm tone	Active	On Off
	Delay	0...60 minutes
	Profile	
5/6 Relay	Active	On Off
	Profile	1 2 1&2
6/6 Delete	Delete element	Execute

Alarm groups

Several measuring channels can be consolidated into one alarm group. The configuration is done in the web user interface.

Test addresses

Display of the stored test addresses. The configuration is done in the web user interface.

You start the test by pressing the TEST button in the footer of the default display screen. Depending on the scope of the test, it may take a few minutes. The result is displayed after the test.



The TEST button only appears if at least one test address has been set up.

9.5 Settings

Digital inputs

Make settings for digital inputs IN1...12. Settings can be made channel by channel.

Channel description

- The channel description that was created in the web application is displayed here.

Mode

- Off
- High-active
- Low-active

t(on)

- The response delay indicates the delay with which the alarm is signalled.
- Setting range 0...600 s

t(off)

- The switch-off delay indicates how long an alarm needs to no longer be present before the message is also cancelled.
- Setting range 0...600 s

Relays 1 - 2

Carry out the relay mode and function for relays 1...2.

Relay mode

- non-fail-safe
- fail-safe

Function

- No selection
- Alarm addresses
- Buzzer

The relay switches as soon as the buzzer sounds. In this way, other signalling devices can be installed to indicate pending messages on the CP305.

- Alarm addresses | Buzzer

The relay switches when it is configured for an alarm address or when the buzzer sounds.

- Test Isometer
Relay switches for approx. 30 seconds when a test of the assigned devices (insulation monitoring devices, LIM, GFCI) is triggered using the “TEST” button.
- Switch
Relay can be switched manually via a button on the start page.
Setting the widget in the web application under

 **Tools > Device management > Main page > Type = Switch**

Interface

The settings for the different interfaces can be made here and the current parameter configuration is also displayed.

Ethernet

- DHCP (On, Off); IP address (DHCP)
- Manual: assign an IP address for the local network



The IP address assigned automatically for a 1:1 connection cannot be changed.

RS-485

- Protocol (BMS|Modbus RTU)



*A CP305 can only belong to one RS-485 bus (BMS **or** Modbus RTU). Parallel operation of both protocols is not possible.*

Settings for BMS	Settings for Modbus RTU
BMS address (1...90)	Baud rate (9.6 19.2 38.4 57.6 115.2 kBaud)
Interval (1...3 s)	Parity (Even Odd None)
Acknowledge via interface (On Off)	Stop bits (1 2 auto)
	Alarm polling interval (0...30 s)

NFC



NFC can only be enabled for a certain time so that parameters can be configured.

- Enabled (1 h|12 h|Off)
- End (timestamp for when NFC is disabled once again)



When the NFC interface is enabled, this is shown on the device in the header by .

General

- Device identification

Individual texts

Individually assigned texts such as device name and digital inputs are displayed but cannot be edited here. Changes are to be made using the web browser and are automatically applied.

Delete history

Delete the saved history in the device and in the web user interface. This step cannot be undone.

i *If you want to save the history, **export the history before deleting** it under Menu > History > Export in the web user interface.*

Date and time

Setting option for

- Time, date, time zone, summer time
- Time synchronisation with time server (SNTP) (off|auto (DHCP)|on)

i *The time server is queried hourly.*

Display

General

- Alignment (horizontal|vertical)
- Cleaning mode active
Setting option: deactivated or locked for 5...20 s
- Display time (off|on) in the header

Language

- Display language 2
A second language can be selected and set for the display via the list. This can be easily activated by the operating personnel using the country flag in the header.

Alarm messages

- Set the time until the page is changed for several pending alarms.
Setting range: 3|5|10 seconds

Standby mode

- Timeout (display) after 1...10 minutes
- Standby mode (off|automatic dimming|display time)
- Brightness (off|10...90 %)

i *In the event of an alarm, the display is always at 100 % brightness. Only after the alarm has been eliminated does the CP305 go into standard operation with the configured standby mode.*

The display only shows most of the settings. You can make some settings as soon as the administrator has logged into the device with a PIN (factory setting 8070). The complete configuration takes place in the web browser.

Security

Display

- PIN (enabled|disabled)
- Change PIN

i *The display PIN for logging on to the device always consists of 4 digits.
The factory setting for the PIN is 8070.
If you forget the PIN, you can reset it in the web user interface.*

Server

- **Administrator**
 - User name (display only)
 - Status (enabled|disabled)
 - Password (only *** is shown)
 - Read access (allow)
 - Write access (allow)
- **User**
 - User name (display only)
 - Status (enabled|disabled)
 - Password (only *** is shown)
 - Read access (allow)
 - Write access (deny)
- **Not logged in**
 - Read access (allow)
 - Write access (deny)

Buzzer

Setting options

- Volume (high|normal|low)
- Mute alarm (off|1...8 h)

End (mute) - date and time at which the mute is automatically cancelled again.

When the device is muted, the LED and header turn blue. A note appears in the header (e.g. buzzer muted 1 h), along with the crossed-out loudspeaker icon .



This setting is used for putting into service. It does not meet the requirements of the standard for audible alarms.

Service inspection



During the service inspection, the system does not meet the requirements of the standard for audible and visual alarms.

Service interval

(deactivated, 3 months ... 4 years)

Prewarning

(deactivated, 1 week ... 3 months) – message before the service interval expires so that plans can be made for the next inspection.

Next service

(display only)

Next service

Only displayed when a service interval is set.

Last service

Date display on which date the last service check was carried out.

Service inspection

The service inspection is started here.



For the service inspection, it is necessary to first create at least one alarm address.

Factory setting

- Restart device (Execute)
- Factory settings without interface: The device is reset to the factory settings, and individual interface settings are retained.
- Factory settings with interface: The device is reset to factory settings, and individual interface settings are discarded.

9.6 Info

Display of the most important device parameters

- Device name
- Article number
- Serial number
- Firmware
- Bootloader
- BMS address
- IP address
- MAC address

10 Web user interface: menu structure (via ETH socket)

This chapter describes how to access the device through the IP address set for it. You will find it in the device menu  > Info.

If you want to access the CP305 through a gateway, there is a limited range of functions when doing so.

In terms of your browser, we recommend using the latest versions of Google Chrome, Microsoft Edge or Mozilla Firefox. You need to activate JavaScript to use the functions of the web user interface. The pop-up blocker should be disabled for the IP address of the CP305.

 *With Windows® Internet Explorer, it is necessary to always disable Compatibility View. Select Extras > Compatibility View Settings. Deactivate the button **Show intranet sites in the Compatibility View**.*

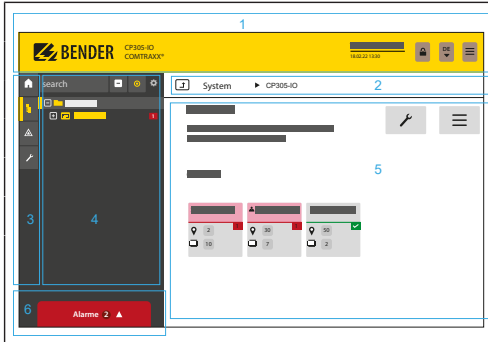

Start page of the COMTRAXX® user interface

1. Open an Internet browser.
2. Enter the IP address of the CP305 on the address line (example: http://172.16.60.72).

	No.	Element
	1	Header
	2	Path indicator
	3	Navigation
	4	Subnavigation
	5	Content section
6	Alarm overview	

10.1 COMTRAXX® user interface





10.1.1 Header

Element	Description
	Click the logo: Return to the start page
CP305 COMTRAXX®	Device used: Device type
System x y 2023-01-16 09:47 (+01:00)	Device used: System name > Subsystem > Device address Date and time of the device
	The icon shows that the web user interface is protected by a password. Click the icon and then log in to enter the username and password
EN ▼	Language selection

Element	Description
	Open/close the navigation (button only available with small browser window)

 If you have forgotten the password, the Bender service can generate a one-time password. Have your serial number ready for this.



10.1.2 Navigation

	Menu	Description
	Start	Display information about the device and the software. Please have this information ready if you call to ask questions.
	System overview	In the system overview, all devices in the system are displayed either by subsystem or by interface. Pending alarms and operating messages are displayed. The CP305 can be configured.
	Alarms	Display of all pending alarms as well as the data of the alarming devices.
	Tools	Functions that affect the entire system

The navigation icons are visible on the left edge at all times. Even if you have just opened any other submenu of the web user interface, you can jump directly to one of the four sections by clicking the desired icon.

10.1.3 Subnavigation

The system overview is displayed in the subnavigation.

Element	Description
Search	Full text search in the system for device names or menu items. Found locations are highlighted in yellow.
–	Close the expanded tree in the subnavigation
	Automatically expand: If active (= yellow), the displayed content of the content section is also shown in the subnavigation with automatically expanding device tree in addition to the path indicator. The path indicator and the content section are always synchronised. If switched off (= white), the subnavigation is not adapted to the path indicator or the current content section.
	- Sets whether the view is by subsystem or by interface. - Configure the row height of the entries.

10.1.4 Content section

Display of the system, alarms and entries for the tools .

10.1.5 Alarm overview (footer)

Overview of pending alarms

Click the alarm overview: List of pending alarms

Click the list: Details of the alarms in the content section

History memory of the device

From the alarm overview, you can jump directly to the stored history of the CP305.

10.2 Start

Display of device info (device version, current software, serial number, order number, BCOM name)

10.3 System overview

 > System Overview > System







With direct access via the ETH socket, the "System" is the CP305 itself.



When you click the device "CP305", the following opens in the subnavigation:

- The device tools
- The menu of the device
- The BMS interface (as tile)







In the content section, there is an overview of the BMS interface, the set timers, the set service timer, the configured relays and the assigned digital inputs.

10.3.1 Device tools

 Device tools	
	<p>Document device</p> <p>Here you can create documentation of the selected device as a pdf. By default the documentation contains all parameters and measured values associated with the device as well as device information such as serial number and software version. However, only one of these pieces of information can be selected if desired (see checkbox). The generated document reflects the current state of the device.</p>
	<p>Export backup</p> <p>The following data is part of a backup:</p> <ul style="list-style-type: none"> - Menu parameters - Individual texts relating to the device - For devices of the COMTRAXX series, all relevant configuration files continue to be integrated <p> <i>For security reasons, passwords are not part of a backup.</i></p> <p>In a user-defined backup, you can freely select which data from the device should be saved in it.</p> <p>You switch to the next step by pressing the "Next" button in the footer.</p>

	Import backup	<p>You can import an existing backup here. All information in the backup is compared with the current information on the device. Then you can select the ones you want to import.</p> <p> <i>Important: Please ensure in advance that the backup file is intended for the device!</i></p> <p>You switch to the next step by pressing the "Next" button in the footer.</p>
---	---------------	--

10.3.2 Menu

 Menu		
	History	<p>Up to 1000 entries can be stored. After that, the oldest data is overwritten (FIFO).</p> <p> <i>The history entries can also be viewed on the CP305.</i></p>
	Settings	Setting options such as via the display of the CP305 (see "Settings", Page 36)
	Info	<p>Device name, article number, serial no., firmware, bootloader, status and Ethernet settings, device configuration (quantity of alarm addresses, alarm groups, test addresses used)</p> <p> <i>This information can also be viewed on the CP305.</i></p>

10.3.3 BMS

The content section shows the connected BMS bus of the CP305. Clicking a device will cause the current measured values or alarms to be displayed.

10.3.4 Modbus RTU

The content area shows the Modbus RTU devices of the CP305 that are connected. Clicking on a device displays the current measured values or alarms.

10.4 Alarm overview (footer)

Overview of pending alarms

Click the alarm overview: List of pending alarms

Click the list: Details of the alarms in the content section

History memory of the device

From the alarm overview, you can jump directly to the stored history of the CP305.

10.5 Tools

10.5.1 Monitoring

10.5.1.1 Device failure monitoring

 All devices whose failure is monitored are summarised here in a list.

The CP305 can generate messages when a device on the RS-485 bus fails. To do this, the device must be included in the list of devices to be monitored.

 Tools > Monitoring > Device Failure Monitoring

You can add new entries using the "Add entry" button in the footer.

- **Add existing device**

A device already known to the system is to be added to the list. Navigate through the path indicator to the device to be monitored.

- **Add new device**

A device previously unknown to the system is to be added to the list. This requires that you enter the BMS address of the device to be monitored.

Import actual state

All active devices on the RS-485 bus are displayed as a list.

10.5.1.2 Alarm addresses

Alarms can be defined here and the way they are to be displayed can be configured. Every measuring channel can be selected as an alarm address and be configured individually, e.g. the colour of the alarm pop-up, help texts, sounds, etc.

In addition, every alarm can also be assigned to an alarm group.

Alarm group tab

 First create your alarm **groups**. This allows you to make assignments to the alarm addresses directly during configuration.

Assign individual names and add an icon from the drop-down list as an option.

 Make new entries via the "Add entry" button in the footer.





Alarm addresses tab

Overview of the alarm addresses that have been created including

- Type of the alarm (common alarm, device failure, measured value, error)
- Path
- Assigned colour for alarm message
- Assigned alarm group
- Buzzer
- Individual comment

i Make new entries via the "Add entry" button in the footer.

The following functions are available for every alarm address:

	Display a preview of an alarm message
	Edit entry
	Copy entry
	Delete entry



Footer

Menu item	Explanation
Import	Import the configuration file of the alarm addresses (Excel file) i Only configuration files that were previously exported from a CP305 can be imported. Other Excel files (including exports from other CPx devices) are not supported.
Export	Export the configuration file of the alarm addresses (Excel file) For details, see "Export/import", Page 48.
Import actual state	An alarm address is created for each connected device to help with initial commissioning. The entries can then be adapted individually.
Save changes	Exit the page with saving
Discard changes	Exit the page without saving
Add entry	For details, see "Edit alarm address", Page 46.

10.5.1.3 Edit alarm address

 Tools > Monitoring > Alarm addresses > [Footer] Add entry

or

 Tools > Monitoring > Alarm addresses >  Edit entry

General tab

Menu item	Explanation
Path	Select path via breadcrumb. The selected path can be changed either section by section using the mouse via the selection or using the keyboard.
Priority	The alarm with the highest priority determines the colour of the device LED in the event of an alarm. Note: Priority 10 is higher than priority 5.
Repetition interval	0...60 minutes

Menu item	Explanation
Selection	Options depends on the path that has been defined <ul style="list-style-type: none"> • Device failure • Common alarm • Active on test • Active on prewarning
Select alarm colour automatically	
Alarm colour	Select from 5 colours: Red, yellow, green, blue, violet
Alarm group	The previously created alarm groups are offered for selection.
Comment	Is shown in the overview of the alarm addresses.

Dialogue tab

The information that is displayed within the pop-up in the visualization in the event of an alarm can be configured here.

	Tab (2nd level)	Explanation
Options	<ul style="list-style-type: none"> • Show alarm group • Show device description • Show individual device description • Show individual alarm text • Show channel description of the measuring point • Show individual text of the measuring point • Show measured value • Show path 	Customizable details that are shown in the pop-up.
Image	Selected image	An image can be shown in the pop-up.
	Image library	Up to 10 images can be saved.
	Add image	Supported image formats are: xbm, tif, jfif, ico, gif, svg, jpeg, webp, png, bmp, pip, apng, pjpeg, avif Images are scaled automatically.
Instruction	Show instruction	An aid concerning what to do in the event of an alarm.
	Language	In addition to instructions in the default language, additional languages can also be saved. The corresponding instructions are then displayed when the language is displayed.

Alarm tone tab

The settings for the alarm tones depends on the device. An alarm tone is played as soon as an alarm occurs. If the buzzer is activated, it is possible to configure a delay for the acoustic alarm of 0...60 minutes.



NOTE

For hospital applications in accordance with IEC 60364-7-710 and national regulations, if an alarm delay is used, a second device must be installed to provide an immediate acoustic alarm.

The alarm tone can be selected from a wide variety of profiles.

Relay tab

The relays of the CP305 can be switched in the event of an alarm. Here it is possible to specify whether and which relays are to switch (none, Relay 1, Relay 2, or both).



One relay can only fulfil one function. If the relay is used for a different configuration, it can no longer pass on any alarms.

10.5.1.4 Test addresses

Test addresses

Display the bus addresses that are to carry out a test when the "TEST" button is pressed on the device display. All test addresses are consolidated into one test group.



Only ISOMETERS® can be tested.

10.5.1.5 Export/import

The configured test and alarm addresses can be exported as an Excel file. Configurations can be transferred to (other) CP305 devices by importing this file at a later point in time.



For an export, at least one alarm group and one alarm address must have been created.

The exported Excel file is editable. The "Help" worksheet contains an overview of the expressions and values that can be used.



CAUTION

Do not make any changes to the worksheets "Images", "Meta" and "Help"! Changes here make the file unreadable for the CP305, meaning the file becomes useless.

"Localized Instructions" worksheet

The Excel spreadsheet can be used to transfer multilingual action instructions to a CP305 with little effort. The instruction in the default language must be created. All associated texts require the same ID (= number of the alarm address in the overview). For the definition, the language abbreviation according to ISO 639-1 must be entered in the Language column to ensure that the language selection assignment is successful (de, en, fr, ...).



*In the web interface, translate at least one action instruction in each desired language **before a data export**. You will then find the correct language abbreviation already in the worksheet.*

If a translation is missing in an action instruction, the action instruction in the alarm message is displayed in the default language.

10.5.2 Device management

10.5.2.1 Modbus devices



This menu item is not visible if the CP305 is connected via the BMS bus.

Managing devices

The devices can be integrated into the system here. Among other things, the device address and the channel templates to be used can be specified here. You get a list that provides an overview of the Modbus RTU devices that are connected.

Clicking on the bus address takes you directly to the corresponding device and settings can be made directly via its menu.



10.5.2.2 Start page

Configure the default display screen (start page)



Up to 4 entries on the start page can be arranged individually via the web user interface.

Tools > Device management > Start page

You can create new entries using the “Add entry” button in the footer. The following options are available:

Type	Explanation
Measured value	Navigate to the source of the measured value via “Path”. An explanatory description can also be provided for the measured value displayed. The currently measured value and description are displayed.
Text	Enter any text you would like; this text will be displayed permanently.
Date and time	Display date and time.
Empty line	Blank lines allow the start page to be designed so that not everything is arranged in the upper section when there are less than four entries.
Switch	Shows a switch for manually switching the relay.  <i>The function "Switch" must be selected during the configuration of the relay for this to work.</i>
UL1022 LIM	 <i>This function is only available in combination with an LIM device for the corresponding markets. It is not intended for the IEC area.</i>

Edit entries

	Edit entry
	Delete entry

Footer

- Import: Import the start page configuration file (Excel file)
- Export: Export the start page configuration of as an Excel file
- Save changes
- Discard changes

10.5.3 Service

10.5.3.1 Managing certificates

When HTTPS is enabled, the HTTPS certificates can be managed here.

10.5.3.2 Update

Download a software update from the homepage. Save the file and follow the instructions in the web user interface.

10.5.3.3 Search for device

When you restart a device, it can take up to five minutes before all devices that are integrated into the system can be found and displayed. If devices continue to be missing, you can re-initialise the system.

 *Important note: Search for a device can briefly cause considerable data traffic on the network.*

10.5.3.4 Log files

Log files are saved as txt files. In the event of a fault, log files help Bender Service to more easily find the cause.

10.5.3.5 Document system

Here you can generate documentation of the entire system.

Thereby, the corresponding parameters and measured values as well as device information, such as serial number and software version of all devices in the system, are documented by default. If required, it is also possible to select particular information (see checkbox). Besides that, it is possible to select individual subnets or devices. The generated document determines the current system status and is therefore suitable for system documentation.

10.5.3.6 Device restart

The CP305 can be restarted from the web user interface without it being necessary to disconnect the CP305 from the power supply.

10.5.3.7 TMK-SET import

When swapping out old devices, an existing configuration can be propagated directly.

**NOTE**

Only file imports for **MK2430** are possible.

**NOTE**

Check the configuration to ensure it is correct. Importing the database overwrites the settings for the alarm addresses, test addresses, and device failure monitoring!







10.5.4 Information

- [Link to the manual download on the Bender website](#)
- [Copyright information \(including open source software used\)](#)

11 Web user interface: Menu structure (access via gateway)

If the CP305 is connected to a CP9xx control panel or a COM465 gateway or the like, a device menu of the CP305 can be opened. This can be used to call up device information.

11.1 Device tools

 Device tools	
 Document device	<p>Here you can create documentation of the selected device as a pdf. By default the documentation contains all parameters and measured values associated with the device as well as device information such as serial number and software version. However, only one of these pieces of information can be selected if desired (see checkbox). The generated document reflects the current state of the device.</p>
 Export backup	<p>The following data is part of a backup:</p> <ul style="list-style-type: none"> - Menu parameters - Individual texts relating to the device - For devices of the COMTRAXX series, all relevant configuration files continue to be integrated <p> <i>For security reasons, passwords are not part of a backup.</i></p> <p>In a user-defined backup, you can freely select which data from the device should be saved in it. You switch to the next step by pressing the "Next" button in the footer.</p>
 Import backup	<p>You can import an existing backup here. All information in the backup is compared with the current information on the device. Then you can select the ones you want to import.</p> <p> <i>Important: Please ensure in advance that the backup file is intended for the device!</i></p> <p>You switch to the next step by pressing the "Next" button in the footer.</p>

11.2 Menu

11.2.1 Edit texts

You need to be logged in to the device to create and change individual texts. Changes are saved or discarded in the footer.

Device

This defines how the device is designated in the system.

- Device name (important for setting alarm address parameters, for example)
- Device failure

Channel 1 - 12

For each of the channels 1...12 (digital inputs), custom message texts can be assigned for:

- Description
- Warning
- Prewarning

The individual message texts can be used in the alarm addresses.

11.2.2 Info

Display of

- Device type
- Software
- producer
- Website

12 Export and import of device data

Different device data can be exported via the web user interface. They are exported in the appropriate format depending on the application.



You will find the files in the Download folder of your computer.

Likewise, these files can also be imported back into the CP305 (except pdf).

Export as pdf

 System Overview > System > Device Tools > Document Device

Export/Import as json file

 System Overview > System > Device Tools > Export Backup

During import, the contents of the backup file are compared with the currently configured data. The values to be adopted can be individually selected or deselected.

Export/Import as Excel file

 Tools > Monitoring > Alarm Addresses (export without any setting options)

 Tools > Device Management > Start Page (export without any setting options)

 Tools > Device Management > Individual Texts

The Excel files created can be edited with the usual Excel tools. In the workbook, there is a separate "Help" worksheet in which the structure and permitted contents of the cells are explained.



Expert mode: parameters can be easily set for CP305 using the Excel files ("Quick programming"). Recommended for experienced administrators only.

13 Cleaning, servicing and troubleshooting

13.1 Cleaning

The glass front can be wiped clean with common cleaning agents. The glass and seal are resistant to alcohol-based disinfectants.

13.2 Servicing

The device does not contain any parts that require servicing. Despite this, the intervals specified for periodic verification should be adhered to.

13.3 Error messages

The CP305 indicates parameterised and detected errors on the display; if set to do so, the buzzer also signals the errors.

If the function "Relay active" is set under  Tools > Monitoring > Alarm addresses, the alarm relay also switches.

13.4 LED

The LED on the CP305 indicates the status or alarm mode:

LED colour	Meaning
Off	No power supply; the device is not ready for operation.
Lights up green	The device is in standard mode; no messages are present at the configured alarm addresses.
Lights up red	An alarm message (allocated in red) is present on at least one configured alarm address.
Lights up blue	<ul style="list-style-type: none"> • Device is muted • No alarm addresses have been parameterised yet.
Lights up yellow	An alarm message (allocated in yellow) is present on at least one configured alarm address.
Flashes red	Power supply lost.
Flashes violet	The device boots.



During the alarm, the LED takes on the colour assigned in each case. Green, yellow, red, blue and violet are available.



If several alarms are present at the same time, the LED takes on the colour of the highest-priority alarm.

13.5 Malfunctions

List of possible errors and proposals for the correction of the faults. This error list does not claim to be exhaustive.

Error	Possible cause/actions
No indication on the display of the CP305	Check the AC/DC 24 V power supply.
No indication on the display, but the display is illuminated.	Replace CP305
LEDs do not light up	Replace CP305
Time is reset to zero in case of short-term voltage failure.	Replace CP305
Error on internal BMS bus	Address of devices incorrectly set on internal bus; interface lines A/B are interchanged; the network was incorrectly or not terminated; faulty parameter setting
Digital input function error	Digital inputs not correctly set. Defective connection (does not match pre-assignment). Incorrect setting "neutral/medical".

13.6 Recurring inspections

The following periodic verification must be performed on electrical installations in compliance with the local or national regulations that apply. For your Bender products, we recommend:

Action	Carried out by	Interval
Functional test of the IT system monitoring (insulation, load current, transformer temperature and connection monitoring): Press the "TEST" button on the device display once; close the pop-up when finished.	Med. personnel	Once every working day
Functional test of the changeover device*: functional test of the automatic transfer switching devices. The instructions in chapter "Test of the changeover device" (changeover device manual) must be observed.	Electrically skilled person	Every 12 months
Functional test of the IT system monitoring (insulation, load current, transformer temperature and connection monitoring) on the insulation monitoring device.	Electrically skilled person	Every 12 months
Checking the setting values and changeover periods.	Electrically skilled person	Every 12 months

Action	Carried out by	Interval
Test the changeover device, the IT system monitoring, and the connection to the SCADA system (Supervisory Control and Data Acquisition) (if applicable) as well as the interaction between the components in the system. The test encompasses the following: <ul style="list-style-type: none"> – Inspection: Marking, display elements, mechanical components, wiring, parameter setting, connection of third-party systems, evaluation of fault memory – Measurement: Internal/external supply voltages/potentials, bus voltage, bus protocol, bus scan – Testing: Device function, device communication – Documentation: Test results, recommendations for eliminating defects 	Bender	Every 24 months

* *This test must only be performed by an authorised electrically skilled person in agreement with the medical locations concerned.*

Before carrying out the tests, please refer to the instructions relating to the functional tests in the checklist. If no national directives apply, you should perform the tests recommended by DIN VDE 0100-710 (VDE 0100-710).

14 Technical data

Caution: This equipment is not intended for use in residential environments and may not provide adequate protection to radio reception in such environments.

(Non-domestic environment, CISPR 11:2015/AMD1:2016/AMD2:2019, Group 1, Class A;
IEC 61000-6-4:2018-02 Ed. 3.0)

14.1 Tabular data

()* = factory setting

Insulation coordination acc. to IEC 60664-1

Rated voltage	50 V
Overtoltage category	II
Pollution degree	2

Overtoltage category II and pollution degree 2 is related to the relay contacts.
Further insulation coordination takes place after functional separation.

Supply via plug-in terminal (A1/+, A2/-)

Rated voltage	AC/DC 24 V
Operating range of the supply voltage	AC 18...28 V/DC 18...30 V
Nominal frequency	50/60 Hz
Typical power consumption	< 4.2 W
Maximum cable length with supply via B95061210 (24 V DC power supply unit 1.75 A)	
0.28 mm ²	75 m
0.5 mm ²	130 m
0.75 mm ²	200 m
1.5 mm ²	400 m
2.5 mm ²	650 m

Stored energy time in the event of voltage failure

Time, date	Min. 2 days
Restart after power failure	Min. 2 seconds

Displays, memory

Display	5" TFT touch display (720 x 1280 px)
Displayable devices	90
Number of alarm addresses	500
Number of test addresses	50

Number of history memory entries	1000
----------------------------------	------

Interfaces

Ethernet

Connection	RJ45
Data rate	10/100 Mbit/s, autodetect
DHCP	on/off (on)*
IP address (1:1 connection)	169.254.xx.yy (xx and yy are unique for each device)
Netmask	nnn.nnn.nnn.nnn (255.255.255.0)*
Logs	TCP/IP, Modbus TCP, DHCP, SNTP

Ethernet

Protocol (for reading the digital inputs and relay outputs only)	Modbus TCP
Operating mode	Slave

RS-485

Protocol	BMS internal
Operating mode	Master/slave (master)*
Baud rate	9.6 kBit/s
Cable length	< 1200 m
Shielded cable, one end of shield connected to PE	Recommended: CAT6/CAT7 min. AWG23 Alternative: J-Y(St)Y min. 2 x 0.8
Galvanic separation	Yes
Connection	"RS-485 A", "RS-485 B" (see plug-in terminal)
Terminating resistor	120 Ω (0.25 W), can be connected internally
Device address	1...90 (1)*
Number of supported devices	89

RS-485

Protocol	Modbus RTU
Operating mode	Master
Baud rate	19.2 kBaud
Parity	even, odd, none (even)*
Stop bits	1, 2, auto (1)*
Alarm query interval	0...30 s (2 s)*
Cable length	< 1200 m
Shielded cable, one end of shield connected to PE	Recommended: CAT6/CAT7 min. AWG23 Alternative: J-Y(St)Y min. 2 x 0.8
Galvanic separation	Yes
Connection	"RS-485 A", "RS-485 B" (see plug-in terminal)
Terminating resistor	120 Ω (0.25 W), can be connected internally
Device address	1
Number of supported devices	30

Digital inputs (1...12)

Number	12
Galvanic separation	In groups of four IN 1...4 / GND 1-4 IN 5...8 / GND 5-8 IN 9...12 / GND 9-12
Operating mode	Can be selected for each input: high-active or low-active
Factory setting	Off
Voltage range (high)	AC/DC 10...30 V Nominal: 24 V
Voltage range (low)	AC/DC 0...2 V
Max. current per channel (at AC/DC 30 V)	8 mA
Connection	Plug-in terminals IN 1...4 / GND1-4 IN 5...8 / GND 5-8 IN 9...12 / GND 9-12
Maximum cable length	< 500 m

Switching elements

Connection	Plug-in terminal K1 NC; K1 NO; K1 COM K2 NC; K2 NO; K2 COM
Number of changeover contacts	2
Operating principle (changeover contacts)	N/C operation / N/O operation
Function	Programmable
Minimum contact load	100 mA/DC 5 V (0.5 W)
Electrical endurance under rated operating conditions	10,000 operating cycles

Contact data acc. to IEC 60947-5-1

Utilisation category	AC-13	AC-14	DC-12
Rated operational voltage	AC 24 V	AC 24 V	DC 24 V
Rated operational current	AC 2 A	AC 2 A	AC 2 A

Buzzer

Buzzer alarm	Can be acknowledged, adoption of characteristics of new value, can be muted
Buzzer interval	Configurable
Buzzer frequency	Configurable
Buzzer repetition	Configurable

Device connections

Plug-in terminal (A1/+, A2/-)

Conductor sizes	AWG 24...12
Stripping length	10 mm
Rigid/flexible	0.2...2.5 mm ²
Flexible with ferrules, with/without plastic sleeve	0.25...2.5 mm ²
Multiple conductor flexible with TWIN ferrule with plastic sleeve	0.5...1.5 mm ²

Plug-in terminals

(RS-485 A, RS-485 B), (IN1...4, GND1...4, IN9...12, GND9...12) (IN5...8, GND5...8, K1..., K2...)

Conductor sizes	AWG 24...16
Stripping length	10 mm
Rigid/flexible	0.2...1.5 mm ²
Flexible with ferrule without plastic sleeve	0.2...1.5 mm ²
Flexible with ferrule with plastic sleeve	0.2...1.5 mm ²

For UL applications

Use copper lines only.

Minimum temperature range of the cable to be connected to the plug-in terminals	75 °C
---	-------

Environment/EMC

EMC	IEC 61000-6-2:2016-08 Ed. 3.0 IEC 61000-6-3:2020-07 Ed. 3.0 IEC 61326-1:2020-10 Ed. 3.0 DIN EN 61326-1:2020-10 Ed. 3.0 DIN EN 61326-1:2013-07 DIN EN 50364:2019-05 EN 300 330 V2.1.1 ETSI EN 301 489-3 V2.3.0
Operating temperature	-10...+55 °C
Operating temperature for UL applications	-10...+50 °C
Operating altitude	≤ 2000 m AMSL
Rel. humidity	≤ 98 % at 25 °C

Classification of climatic conditions acc. to IEC 60721

Stationary use (IEC 60721-3-3)	3K22
Transport (IEC 60721-3-2)	2K11
Long-term storage (IEC 60721-3-1)	1K22

Classification of mechanical conditions acc. to IEC 60721

Stationary use (IEC 60721-3-3)	3M11
Transport (IEC 60721-3-2)	2M4
Long-term storage (IEC 60721-3-1)	1M12

Other

Operating mode	Continuous operation
Mounting position	Display-oriented, adjustable horizontal/vertical display orientation
Degree of protection of front glass pane	IP66
Degree of protection of front for UL applications	IP50
Degree of protection of enclosure	IP20
Degree of protection mounted flush with wall	IP54
Flammability class	UL 94V-0
Device dimensions (W x D x H)	181 x 96 x 37.1 mm

Weight

< 420 g

(*) = Factory setting

14.2 Standards and approvals



The current overview of Bender devices with radio approval can be found in the Country list of RF Approval.

14.3 Ordering information

Device variants

Type	Description	Art. No.
CP305-IO		B95100051
CP305-C	Customised parameter settings	B22030051

Accessories

Type	Description	Art. No.
Flush-mounting enclosure		B923710
Cavity wall installation set for flush-mounting enclosure B923710	Installation kit for flush-mounting enclosure	B923711
DIN rail mounting and control panel installation set for flush-mounting enclosure B923710	Installation kit for CPx05	B95101000
CP305 surface-mounting enclosure		B95100153
CP305-IO plug kit	CP305-IO connector kit	B95100151
Ethernet adapter kit (RJ45 socket insert, Cat.6 SLIM patch cable)	Ethernet connector kit	B95100152

14.4 EU Declaration of Conformity

Hereby, Bender GmbH & Co. KG declares that the device covered by the Radio Directive complies with Directive 2014/53/EU. The full text of the EU Declaration of Conformity is available at the following Internet address:

https://www.bender.de/fileadmin/content/Products/CE/CEKO_CP3xx.pdf

14.5 Documentation revision history

Date	Document version	Valid as of software version	State/changes
09.2022	00		First edition
01.2023	01		<i>Editorial revision/correction</i> of texts, images, technical data, ordering information
07.2023	02		<i>Added</i> CP305-C ordering information
02.2024	03		<i>Added</i> Ordering information, mounting kit for panel mounting
02.2025	04	1.5	<i>Added</i> Modbus RTU interface <i>Editorial revision/corrections</i> Operation at the device updated



Bender GmbH & Co. KG

Londorfer Straße 65
35305 Grünberg
Germany

Tel.: +49 6401 807-0
info@bender.de
www.bender.de

Alle Rechte vorbehalten.
Nachdruck und Vervielfältigung nur mit
Genehmigung des Herausgebers.

All rights reserved.
Reprinting and duplicating only with
permission of the publisher.



© Bender GmbH & Co. KG, Germany
Subject to change! The specified
standards take into account the edition
valid until 02.2025 unless otherwise
indicated.