



DC

ISOMETER® isoCHA425HV

Insulation monitoring device with coupling device AGH420-1/AGH421-1

For unearthed DC systems 0 V to 1000 V

Suitable for DC charging stations according to CCS or CHAdeMO

Software version: D0624 V5.xx



Table of contents

1	General information.....	6
1.1	How to use the manual.....	6
1.2	Indication of important instructions and information.....	6
1.3	Signs and symbols.....	6
1.4	Service and Support.....	6
1.5	Training courses and seminars.....	7
1.6	Delivery conditions.....	7
1.7	Inspection, transport and storage.....	7
1.8	Warranty and liability.....	7
1.9	Disposal of Bender devices.....	8
1.10	Safety.....	8
2	Function.....	9
2.1	Intended use.....	9
2.2	Device features.....	9
2.3	Functional description.....	10
2.3.1	R_F and C_e in "CHd" and "CHA" mode (CHAdEMO).....	11
2.3.2	R_F and C_e in "dc" mode (CCS).....	11
2.3.3	Fault location R%.....	11
2.3.4	System leakage capacitance C_e	11
2.3.5	System voltages $U_{n'}$, U_{L1e} and U_{L2e}	12
2.3.6	Functional tests of contactors in the charging station and the vehicle.....	12
2.3.7	Monitoring the insulation resistance.....	12
2.3.8	Undervoltage/overvoltage monitoring.....	12
2.3.9	Voltage monitoring $U_e >$	12
2.3.10	Stop mode.....	13
2.3.11	Self test functions (device errors).....	13
2.3.12	Error codes.....	15
2.3.13	Alarm assignment of the alarm relays K1/K2.....	16
2.3.14	Fault memory.....	16
2.3.15	Reset command (delete fault memory).....	16
2.3.16	Digital interface.....	17
2.3.17	Measuring and response times.....	17
2.3.18	Password protection (on, OFF).....	18
2.3.19	External test/reset button (T/R).....	18
2.3.20	History memory HiS.....	18

3	Installation, connection and commissioning.....	19
3.1	Dimensions.....	19
3.2	Installation.....	19
3.3	Connection.....	20
3.4	Commissioning.....	21
4	Operation.....	23
4.1	Operating and display elements.....	23
4.2	Menu overview.....	25
4.3	Displaying measured values.....	26
4.4	Setting the response values (AL).....	26
4.4.1	Response values overview.....	26
4.4.2	Setting the response values for monitoring the insulation resistance.....	27
4.4.3	Setting the response values for undervoltage and overvoltage.....	27
4.4.4	Enable voltage monitoring $U_e >$	27
4.4.5	Set the response value for C_e in the cable-check.....	28
4.5	Configuring fault memory, alarm relays, and interfaces (out).....	28
4.5.1	Configuring the relays.....	28
4.5.2	Assigning the alarm messages to the relays.....	28
4.5.3	Activating or deactivating fault memory.....	29
4.5.4	Configuring interface.....	29
4.6	Setting delay times and self test cycles / cable-check (t).....	30
4.7	Setting device control parameters (SEt).....	30
4.8	Reset to factory settings.....	31
4.9	Showing and deleting the history memory.....	31
4.10	Querying software version (InF).....	31
5	Data access via RS-485 interface.....	32
5.1	Data access using the BMS protocol.....	32
5.2	Data access using the Modbus RTU protocol.....	32
5.2.1	Reading out the Modbus register from the ISOMETER®.....	32
5.2.2	Writing the Modbus register (parameter setting).....	33
5.2.3	Exception code.....	34
5.3	Modbus register assignment.....	34
5.3.1	Modbus measured value registers.....	34
5.3.2	Modbus parameter register.....	38
5.4	IsoData data string.....	42

6	Technical data.....	43
6.1	Technical data isoCHA425HV.....	43
6.2	Technical data AGH420-1 and AGH421-1.....	47
6.3	Connection (for ISOMETER® and AGH).....	49
6.4	Standards and certifications.....	50
6.5	Ordering data.....	50
6.6	Document revision history.....	51

1 General information

1.1 How to use the manual



ADVICE

This manual is intended for qualified personnel working in electrical engineering and electronics! Part of the device documentation in addition to this manual is the enclosed supplement 'Safety instructions for Bender products'.



ADVICE

Read the operating manual before mounting, connecting and commissioning the device. Keep the manual within easy reach for future reference.

1.2 Indication of important instructions and information



DANGER

Indicates a high risk of danger that will result in death or serious injury if not avoided.



WARNING

Indicates a medium risk of danger that can lead to death or serious injury if not avoided.



CAUTION

Indicates a low-level risk that can result in minor or moderate injury or damage to property if not avoided.



ADVICE

Indicates important facts that do not result in immediate injuries. They can lead to malfunctions if the device is handled incorrectly.



Information can help to optimise the use of the product.

1.3 Signs and symbols



Disposal



Protect from moisture



Protect from dust



Temperature range



Recycling



RoHS directives

1.4 Service and Support

Information and contact details about customer service, repair service or field service for Bender devices are available on the following website: [Fast assistance | Bender GmbH & Co. KG.](#)

1.5 Training courses and seminars

Regular face-to-face or online seminars for customers and other interested parties:

www.bender.de > know-how > seminars.

1.6 Delivery conditions

The conditions of sale and delivery set out by Bender GmbH & Co. KG apply. These can be obtained in printed or electronic format.

The following applies to software products:



'Software clause in respect of the licensing of standard software as part of deliveries, modifications and changes to general delivery conditions for products and services in the electrical industry'

1.7 Inspection, transport and storage

Check the shipping and device packaging for transport damage and scope of delivery. In the event of complaints, the company must be notified immediately, see 'www.bender.de > service & support.'

The following must be observed when storing the devices:

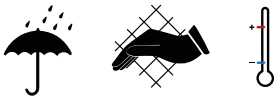

1.8 Warranty and liability

Warranty and liability claims for personal injury and property damage are excluded in the case of:

- Improper use of the device.
- Incorrect mounting, commissioning, operation and maintenance of the device.
- Failure to observe the instructions in this operating manual regarding transport, commissioning, operation and maintenance of the device.
- Unauthorised changes to the device made by parties other than the manufacturer.
- Non-observance of technical data.
- Repairs carried out incorrectly.
- The use of accessories or spare parts that are not provided, approved or recommended by the manufacturer.
- Catastrophes caused by external influences and force majeure.
- Mounting and installation with device combinations not approved or recommended by the manufacturer.

This operating manual and the enclosed safety instructions must be observed by all persons working with the device. Furthermore, the rules and regulations that apply for accident prevention at the place of use must be observed.

1.9 Disposal of Bender devices

Abide by the national regulations and laws governing the disposal of this device.



For more information on the disposal of Bender devices, refer to www.bender.de > service & support.

1.10 Safety

If the device is used outside the Federal Republic of Germany, the applicable local standards and regulations must be complied with. In Europe, the European standard EN 50110 applies.



DANGER Risk of fatal injury due to electric shock!

Touching live parts of the system carries the risk of:

- Risk of electrocution due to electric shock
- Damage to the electrical installation
- Destruction of the device

Before installing the device and before working on its connections, make sure that the installation has been de-energised. The rules for working on electrical systems must be observed.

2 Function

2.1 Intended use

The ISOMETER® isoCHA425HV in combination with the AGH420-1/AGH421-1 coupling device monitors the insulation resistance R_F for DC fast charging stations according to the CHAdeMO standard or according to the Combined Charging System (CCS) for nominal system voltage ranges between DC 0 V and 1000 V.

In order to meet the requirements of the applicable standards, customised parameter settings must be made on the equipment in order to adapt it to local equipment and operating conditions. Please heed the limits of the range of application indicated in the technical data.

Any other use or a use that goes beyond this constitutes improper use.

i To ensure that the ISOMETER® functions correctly, an internal resistance of $\leq 1 \text{ k}\Omega$ must exist between L1/+ and L2/- via the source (e.g. PSU) or the load.

i If the ISOMETER® is installed inside a control cabinet, the insulation fault message must be audible and/or visible to attract attention.

2.2 Device features

- Monitoring of the insulation resistance R_F of DC charging stations in accordance with the CHAdeMO standard or Combined Charging System (CCS)
- CHAdeMO (Mode CHd and CHA):
 - Maximum system leakage capacitance $1.6 \mu\text{F}$ per conductor
 - Detection of insulation faults in the system voltage range from 50 V to 1000 V
 - Response time for one-pole insulation faults R_{FU} :
 - $R_{FU} \leq 100 \text{ k}\Omega$: max. 1 s
 - $100 \text{ k}\Omega < R_{FU} \leq 2 \text{ M}\Omega$: max. 10 s
 - Response time for two-pole insulation faults R_{FS} (Mode CHd only):
 - $R_{FS} \leq 160 \text{ k}\Omega$: max. 10 s
 - $R_{FS} > 160 \text{ k}\Omega$ (200 k Ω): no detection (deactivation)
- CCS (Mode dc):
 - Detection of insulation faults up to 2 M Ω
 - Maximum system leakage capacitance C_e : 20 μF
 - Response time t_{an} at $C_e \leq 5 \mu\text{F}$ or $R_F \leq 100 \text{ k}\Omega$: max. 10 s
- Measuring the system leakage capacitance C_e
- Measuring the system voltage U_n (True-RMS) with undervoltage/overvoltage detection
- Measuring the DC residual voltages U_{L1e} (L1/+ to PE) and U_{L2e} (L2/- to PE)
- Selectable start-up delay, response delay and delay on release
- Two separately adjustable response value ranges from 5...600 k Ω (prewarning, alarm)
- Alarm output via LEDs ("AL1", "AL2"), display, and alarm relays ("K1", "K2")
- Automatic device self test with connection monitoring

- Selectable n/c or n/o relay operation
- Measured value indication via multi-functional LC display
- Activatable fault memory
- Password protection against unauthorised changing of parameters
- RS-485 (galvanically isolated) including the following protocols:
 - BMS (Bender measuring device interface) for the data exchange with other Bender devices
 - Modbus RTU
 - IsoData (for continuous data output)
- Stop mode for disabling the measuring pulse generator and in combination with AGH421-1 disconnection from the monitored system.

2.3 Functional description

The ISOMETER® is designed for use in DC charging stations according to CHAdeMo standard or Combined Charging System (CCS) and can be set to the respective mode in the “SET” menu or via the Modbus parameter. Programmable parameters are stored in a non-volatile data memory and are retained even after the power supply was interrupted.

It measures:

- the total insulation resistance R_{FS}
- the one-sided insulation resistance R_{FU}
- the system leakage capacitance C_e
- the system voltage U_n (True RMS) between L1/+ and L2/-
- the DC system voltages (residual voltages) U_{L1e} and U_{L2e} between L1/+ as well as L2/- and earth

Depending on the selected mode, R_{FS} and R_{FU} are combined to the value R_F . For R_F a prewarning and an alarm limit value can be set in the “AL” menu. The prewarning limit value can only be set higher than the alarm limit value. If the measured value reaches or falls below the limit values, an alarm is signalled. For the measured value U_n an overvoltage and undervoltage limit value can be enabled and adjusted, the violation of which triggers an alarm. The limit value alarms are deleted when the respective measured value no longer violates the limit value including the corresponding hysteresis.

All alarms generated by the ISOMETER® are signalled via the LEDs “AL1” and “AL2”. In the “out” menu, the alarms can be assigned to the alarm relays (“K1”, “K2”). In addition, the operation of the alarm relays (n.o./n.c.) can be configured and the fault memory “M” can be activated or deactivated. If the fault memory is activated, the alarm relays remain in alarm condition until the reset command is triggered or the supply voltage U_s is interrupted.

In the “t” menu, the start-up delay at device start, the response delay and the delay on message release as well as the repetition time of the automatic device self test can be set.

For the RS-485 interface, the protocols BMS, Modbus RTU or isoData are selected in the “out” menu. The measured values can be read and the parameters of the ISOMETER® can be set via the BMS protocols, e.g. using the BMS Ethernet gateway (COM465IP) and Modbus RTU. If the isoData protocol is selected, the ISOMETER® only sends the measured values, once per second.

The device function can be tested using the test button “T”.

The device parameters are set via the LC display and via the control buttons on the front panel. This function can be password-protected.

The ISOMETER® can be set to stop mode to deactivate the measuring pulse generator. Using the AGH421-1, stop mode also disconnects the ISOMETER® from the monitored system.

2.3.1 R_F and C_e in “CHd” and “CHA” mode (CHAdEMO)

The insulation fault R_F and the system leakage capacitance C_e are only determined for DC system voltages ≥ 50 V. The maximum permissible system leakage capacitance C_e is 1.6 μF per conductor. In mode “CHd” the value R_F is determined by the smaller of the values R_{FU} and R_{FS} . R_{FU} is the one-pole total insulation fault determined from the voltages U_{L1e} and U_{L2e} up to a maximum of 2 M Ω .

R_{FS} is the two-pole insulation fault. It is only determined up to a maximum of 160 k Ω . As soon as R_{FS} falls below 160 k Ω , it is thereafter evaluated up to max. 200 k Ω .

The response time of the one-pole insulation fault R_{FU} is 1 s for limit values up to 100 k Ω and $U_n \geq 100$ V. For values outside these ranges, the response time of R_F is max. 10 s.

In “CHA” mode, only the one-pole insulation fault R_{FU} is evaluated and not the two-pole isolation fault R_{FS} .

2.3.2 R_F and C_e in “dc” mode (CCS)

The insulation fault R_F up to 2 M Ω and the system leakage capacitance C_e are determined independently of the system voltage. The maximum permissible system leakage capacitance is 20 μF . The response time for R_F is 10 s.

2.3.3 Fault location R%

From $U_n > \text{DC } 20$ V the fault location R% is calculated for insulation faults R_F up to 500 k Ω (“CHd” mode 150 k Ω).

Value	Meaning
-------	---------

-100 %	one-pole insulation fault at L2/-
0 %	symmetrical insulation fault
+100 %	one-pole insulation fault at L1/+

For values of 30 % and more, the alarm assignment of the relays distinguishes between insulation faults at L1/+ and L2/-.

From the values R% and R_F the partial resistances R_{F+} and R_{F-} can be calculated using the following formulas:

- Fault at conductor DC+: $R_{F+} = (200 \% \times R_F) / (100 \% + R\%)$
- Fault at conductor DC-: $R_{F-} = (200 \% \times R_F) / (100 \% - R\%)$

2.3.4 System leakage capacitance C_e

The system leakage capacitance C_e is determined for insulation faults $R_F > 10$ k Ω up to a value of 35 μF . Above 30 μF , the message Device error “E.07” is displayed.

For applications according to UL 2231-1/-2, the system leakage capacitance C_e is limited to 10 μF .

During the cable-check phase, C_e can be checked for the limit value “Ce>”.

2.3.5 System voltages U_n , U_{L1e} and U_{L2e}

The system voltage U_n between terminals L1/+ and L2/- is measured as RMS value (True-RMS). Limit values for overvoltage and undervoltage are available in the "A" menu; see "Setting the response values (AL)", page 26. Above 1200 V, the message "Overvoltage" is displayed regardless of the set overvoltage limit value.

The DC system voltages U_{L1e} and U_{L2e} are respectively measured between terminals L1/+ as well as L2/- and earth. If voltage monitoring "Ue>" is activated, a message is issued if the value of U_{L1e} or U_{L2e} is higher than 550 V or $U_n \times 110\%$.

2.3.6 Functional tests of contactors in the charging station and the vehicle

If the ISOMETER® is disconnected on one pole from the monitored voltage source during a functional test of the charging station or vehicle contactors, a false alarm may occur depending on the location of an existing insulation fault. For insulation faults above 600 kΩ the false alarm can be prevented by a resistor of 200 kΩ connected directly between the terminals L1/+ and L2/-.

2.3.7 Monitoring the insulation resistance

The insulation resistance R_F is monitored by means of the parameters "R1" (prewarning) and "R2" (alarm) (see chapter 4.4.1). The value "R1" can only be set higher than the value "R2". If the insulation resistance R_F reaches or falls below the activated values "R1" or "R2", an alarm message is triggered. If R_F exceeds the values "R1" or "R2" plus the hysteresis value, the alarm will be cleared.

2.3.8 Undervoltage/overvoltage monitoring

To monitor the system voltage U_n , the two parameters "U<" and "U>" can be enabled in the response-value menu "AL" (see chapter 4.4). The maximum undervoltage value is limited by the overvoltage value.

The RMS value of the system voltage U_n is monitored. If the system voltage U_n reaches, falls below, or exceeds the limit values "U<" and "U>", an alarm will be signalled. If the maximum permissible system voltage U_n set for the ISOMETER® is exceeded, an alarm message will be triggered even if the overvoltage limit value has been deactivated. The alarm will be deleted when the limit values plus hysteresis (see chapter 4.4.2) are no longer violated.

2.3.9 Voltage monitoring $U_{e>}$

The amount of system voltages to earth (U_{L1e} und U_{L2e}) is monitored for overvoltage. The limit value $U_{e>}$ is determined automatically from the measured system voltage U_n . The response time is approx. 3 s.

Limit value $U_{e>}$:

$110\% \times U_n$ or at least 550 V

Hysteresis:

7 % of the limit value or at least -40 V

The monitoring function can be enabled with the "Ue >" parameter in the "AL" menu item or via Modbus register 3000.

The "Ue >" message can be assigned to the relays in the "out" menu item or via Modbus registers 3027 and 3028..

Relevant standard: IEC 61851-23:2023 (chapter 6.3.1.112.2)

2.3.10 Stop mode

If the measuring pulse interferes with other measuring functions, the ISOMETER® can be set to stop mode, either via the Modbus protocol or by holding the external test/reset button ("T/R").

In stop mode, the measuring pulse generator stops clocking and the measuring function is deactivated. The message "StP" appears on the display. The communication interface returns the identifiers "warning" and "external test".

For applications where the ISOMETER® is temporarily not needed and if it is coupled with the AGH421-1, the isometer can be disconnected from the monitored system by activating stop mode via the Modbus protocol. There is no disconnection if stop mode is activated via the external test/reset button.

2.3.11 Self test functions (device errors)

During the normal measuring function the cyclic test of the μ C as well as the continuous PE connection monitoring run in the background.

User-controlled test functions interrupt the measuring function of the device. They are triggered as follows:

- cyclically via a timer (menu item "t" / "test") or
- via the internal or external test button or
- via the communication interface (COM)
- by terminating stop mode if "cbl" is set in the "test" menu item

In case of a device error, all LEDs flash, the display shows the message "E.xx" according to the table in the section "Error codes", page 15 and, depending on the message assignment, the relays switch.

2.3.11.1 Cyclic background test

The cyclic background test checks the functionality of the μ C. It is not visible to the user and does not influence the measuring function. In case of malfunction, the respective device error messages "E.09" to "E.16" appear.

2.3.11.2 Continuous PE connection monitoring

The connection of terminal "E" of the AGH to the PE protective conductor is monitored continuously and in parallel with the measuring function of the device via the input "KE" of the ISOMETER®, which is also connected to the PE protective conductor. When the connection is interrupted, error code "E.01" appears for PE connection error.

2.3.11.3 User-controlled test functions

The user-controlled test functions interrupt the measuring function of the device. They always include a test of the measurement technology (error code "E.05") and additionally a test of the connection between the terminals L1/+ and L2/- via the system to be monitored (error code "E.02") which can be activated by the user (menu "SEt" / "nEt").

If these test functions are started via a test button or the communication interface, this can be indicated not only by the LEDs AL1 and AL2 lighting up but also by the message "test" via the relays (menu "out" / "Signalling assignment").

System connection test

The system connection test configurable in the menu "SEt"/"nEt" checks the connection between the terminals L1/+ and L2/- via the monitored system. For the ISOMETER® to function correctly, the monitored system must have a low internal resistance $R_i < 1 \text{ k}\Omega$.

The "on" setting is used in systems with $U_n < \text{DC } 100 \text{ V}$. When "on U" is set, the system voltage must be $U_n > \text{DC } 100 \text{ V}$ during the test.

If an error is detected, the message Device error system connection "E.02" appears. If the System voltage U_n is below $\text{DC } -30 \text{ V}$ during the mains connection test, the message Device error polarity reversal "E.03" also appears.

Internal and external test button

Pressing the external test/reset button or the test button "T" on the device ($> 1.5 \text{ s}$) starts the user-controlled test functions. Holding the test button "T" on the device also shows all available display elements.

Timer for test functions

At menu item "t"/"test" the user-controlled test can be activated in a cycle of one or 24 hours. The timer restarts after each completed test, regardless of whether it was triggered by the timer or manually.

Self test at device start

At menu item "SEt"/"S.Ct" the execution of the user-controlled test functions can be activated for the time of the device start.

2.3.11.4 Cable-Check

IEC 61851-23:2023 requires both a self test of the IMD and an insulation test for the cable-check phase (CC.4.1.2).

With the "cbl" setting, both tests are performed sequentially as soon as the isoCHA425HV

- restarts in "Stop mode" (see chapter 2.3.10) or
- receives the "TEST" command during normal operation (duration approx. 15 s).

In order for the IMD to carry out the time-optimised self test and insulation test for the cable-check phase, the "test" parameter must be set to "cbl" either in the "t" menu item or via Modbus register 3021.

The maximum system leakage capacitance C_e should not exceed $5 \mu\text{F}$ during the cable-check.

During the cable-check phase, the system leakage capacitance C_e can be checked for exceeding the limit value "ALARM / $C_e > \text{test}$ ". The check must be activated in the limit value parameter. A pending alarm C_e can be cancelled with the reset command after the end of the cable-check, see 2.3.15 Reset command (delete fault memory) .

The IMD's self test function requires less processing time in the "cbl" setting, but only tests some of the measurement electronics in stop mode.

Cable-check procedure

IMD with setting "cbl"			
Operating mode	U_{IMD}	Function	Message
Stop mode active: "StP"	const.	Cyclical test of the μC registers and the offset control in the internal measurement path	TEST
Stop mode inactive: Cable-check	clocked	Testing of internal R_f measurement path with U_{IMD} and KE signal; measurement of R_f , C_e and (if enabled) connection monitoring L1/L2	TEST (Alarm E.xx)
Measurement mode	clocked	End of cable-check and changeover to measurement mode	Operation or alarm R_f

U_{IMD} : IMD Messspannungsquelle measuring voltage source

Relevant standard: IEC 61851-23:2023 (chapter CC.4.1.2)

2.3.12 Error codes

In the event of a device error the display shows the respective **error code**.

Overview of some error codes

Error code	Meaning
E.01	<p>PE connection error The connection of "E" or "KE" to earth is interrupted. Action: Check connection, eliminate error. The error code will be erased automatically once the error has been eliminated.</p>
E.02	<p>System connection error The internal resistance of the system is too high or the connection of "L1/+ " or "L2/- " to the system is interrupted. The terminals "L1/+ " and "L2/- " are connected incorrectly. Action: Check connection, eliminate error. The error code will be erased automatically once the error has been eliminated.</p>
E.03	<p>Reversed polarity connection error Terminals "L1/+ " and "L2/- " are connected to the DC system to be monitored with reversed polarity. Detection from $U_n < \text{DC} - 30 \text{ V}$</p>
E.05	<p>Measurement error Due to system interferences or a device error, the insulation measured value is no longer updated. Prewarning and alarm are set for the insulation measured value at the same time. Calibration invalid after software update "E.05" appears together with "E.08": The software is not compatible to the calibration of the device. Action: Install the previous software version or have the device calibrated at the factory.</p>
E.07	<p>Permissible system leakage capacitance C_e exceeded The device is not suitable for the present network leakage capacitance C_e. Action: Uninstall the device.</p>

Error code	Meaning
E.08	Calibration error Action: Check connection, eliminate error. If the error is still present, there is a device error.

Internal device errors "E.xx" can be caused by external disturbances or internal hardware errors. If the error message occurs again after the device has been restarted or after a reset to the factory settings (menu item "FAC"), the device must be repaired. After the fault has been eliminated, the alarm relays switch back either automatically or when the reset button is pressed. The self test can take a few minutes.

2.3.13 Alarm assignment of the alarm relays K1/K2

The notifications for "device error", "insulation fault", "undervoltage/overvoltage fault U_n ", "self test", "Alarm C_e " (during cable-check), "overvoltage U_e " and "device start with alarm" can be assigned to the alarm relays via the "out" menu.

An **insulation fault** is indicated by these messages:

- "+R1" and "+R2": insulation fault assigned to conductor L1/+
- "-R1" and "-R2": insulation fault assigned to conductor L2/-

If an assignment to a conductor is not possible, e.g. due to a symmetrical insulation fault, the respective "+" and "-" messages are set together.

The message "test" indicates a **self test** triggered manually via a test button or the communication interface.

The message "S.AL" indicates a **device start with alarm**. When the parameter value is set to "S.AL = on" and the supply voltage U_s is connected, the ISOMETER® starts with the insulation measured value $R_F = 0 \Omega$ and sets all activated alarms. The alarms will be cleared only when the measured values are up-to-date and no thresholds are violated. In the factory setting "S.AL = off", the ISOMETER® starts without an alarm.



Recommendation: Set parameter value "S.AL" identical for both relays.

2.3.14 Fault memory

Disabled (OFF)

The LEDs and relays signal the fault as long as it is detected.

Enabled (on)

The LEDs and relays signal the fault until a reset is performed or the supply voltage U_s is disconnected.

2.3.15 Reset command (delete fault memory)

Reset procedure:

- The measured raw value (without averaging) is accepted as the measured value. This enables a quick back measurement to high-resistance insulation values, as required for certain charging station topologies.
- The corresponding measured value is compared with its nominal limit value (i.e. without taking hysteresis into account).
- The result is stored in the fault memory (if activated).

Trigger reset command:

- briefly connect the T/R input to earth ($t < 1.5$ s) or
- press and hold the “R” device button ($t > 1.5$ s) or
- write the value 0x434C to Modbus register 8006.

2.3.16 Digital interface

The ISOMETER® uses the serial hardware interface RS-485 with the following protocols:

- **BMS**

The BMS protocol is an essential component of the Bender measuring device interface (BMS bus protocol). Data transmission generally makes use of ASCII characters.

- **Modbus RTU**

Modbus RTU is an application layer messaging protocol, and it provides master/slave communication between devices that are connected via bus systems and networks. Modbus RTU messages have a 16-bit CRC (cyclic redundant checksum), which guarantees reliability.

- **IsoData**

The ISOMETER® sends an ASCII data string with a cycle of approximately 1 second. Communication with the ISOMETER® in this mode is not possible, and no additional sender may be connected via the RS-485 bus cable. The ASCII data string for the ISOMETER® is described in chapter 5.4.



The IsoData protocol can be terminated by sending the command “Adr3” during a transmission pause of the ISOMETER®.

The parameter address, baud rate and parity for the interface protocols are configured in the “out” menu.



With “Adr = 0”, the menu entries baud rate and parity are not shown in the menu and the IsoData protocol is activated.

With a valid bus address (i.e. not equal to 0), the menu item “baud rate” is displayed in the menu. The parameter value “---” for the baud rate indicates the activated BMS protocol. In this case, the baud rate for the BMS protocol is set to 9600 baud.

If the baud rate is set unequal to “---”, the Modbus protocol with configurable baud rate is activated.

2.3.17 Measuring and response times

The measuring time is the period essential for the detection of the measured value. The measuring time is reflected in the operating time t_{ae} . For the insulation resistance measured value, it is mainly determined by the necessary measuring pulse duration, which depends on the insulation resistance R_f and the system leakage capacitance C_e of the system to be monitored. The measuring pulse is generated by the measuring pulse generator integrated in the ISOMETER®. The measuring times for C_e , U_{L1e} , U_{L2e} and R % are synchronous.

System disturbances may lead to extended measuring times. In contrast, the time for the system voltage measurement U_n is independent and considerably shorter.

Operating time t_{ae}

The operating time t_{ae} is the time required by the ISOMETER® to determine the measured value. The insulation resistance measured value depends on the insulation resistance R_f and the system leakage capacitance C_e .

Response delay t_{on}

The response delay t_{on} is set uniformly for all alarm messages in the “t” menu using the parameter “ton”, while each alarm message specified in the alarm assignment has its own timer for t_{on} . This delay can be used for interference suppression in the case of short measuring times.

An alarm message will only be signalled when a limit value of the respective measured value is violated for the duration of t_{on} . Each time the limit value is violated within the time t_{on} , the response delay “ton” restarts.

Total response time t_{an}

The total response time t_{an} is the sum of the operating time t_{ae} and the response delay t_{on} .

Delay on release t_{off}

The delay on release t_{off} can be set uniformly for all alarm messages using the parameter “toff”, while each alarm message specified in the alarm assignment has its own timer for t_{off} .

An alarm message will be signalled until the limit value of the respective measured value is no longer violated (including hysteresis) for the duration of t_{off} without interruption. Each time a limit value is no longer violated during t_{off} , the delay on release “toff” restarts.

Start-up delay t

After connecting the supply voltage U_S , the alarm output is suppressed for the time set in parameter “t” (0...10 s).

2.3.18 Password protection (on, OFF)

If password protection is activated (on), settings can only be made after entering the password (0...999). For its activation, see chapter 4.7.

2.3.19 External test/reset button (T/R)

Functions

- Reset = press the external button < 1.5 s
- Reset + self test = press the external button > 1.5 s
- Stop mode = press and hold the external button

Only one ISOMETER® may be controlled via an external test/reset button.

A galvanic parallel connection of several test or reset inputs for testing multiple insulation monitoring devices is not allowed.

2.3.20 History memory HiS

The history memory saves exclusively the measured values for the first fault. The history memory must first be cleared before new measured values can be saved.

The values checked in the table in section “Displaying measured values”, page 26 can be saved.

3 Installation, connection and commissioning

3.1 Dimensions

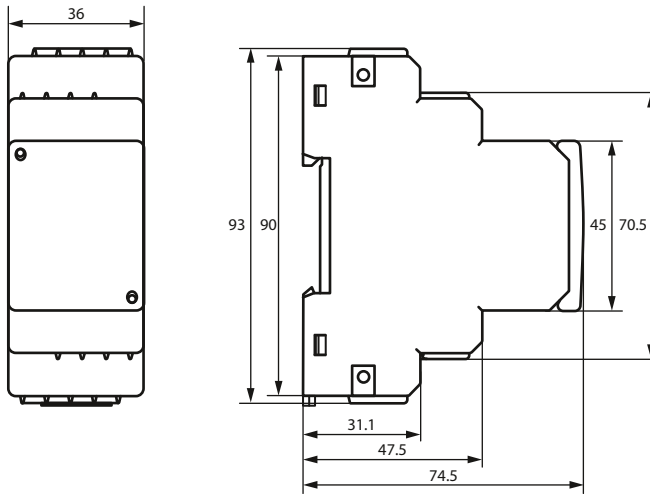

Figure: Dimension diagram (in mm)

3.2 Installation



CAUTION Property damage due to heat

When operating on system voltages $U_n > 800$ V, the housing of the AGH can become hotter than 60 °C.

- Mount AGH with 30 mm lateral clearance to adjacent devices.

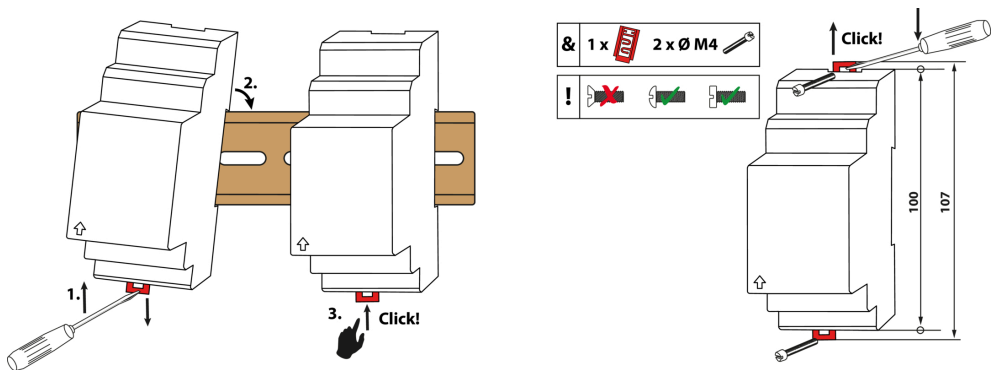

Figure: DIN rail mounting (left) or screw mounting (right)

3.3 Connection



CAUTION Danger from touching hot surfaces!

If the AGH is operated at system voltages > 800 V, the temperature of the enclosure may exceed 60 °C.

- Do not touch the surfaces of the device after connecting it to the system voltage.

For details about the required conductor cross sections, refer to chapter "Technical data", page 43.

Wiring diagram legend:

Terminal	Connections
A1, A2	Connection to the supply voltage U_s via fuse: If supplied from an IT system, both lines have to be protected by a fuse.*
E, E, KE	Connect each terminal separately to PE: Use the same wire cross section as for "A1", "A2".
L1/+, L2/-	Connection to IT system to be monitored
Up, AK1, GND, AK2	Connect the terminals of the AGH to the corresponding terminals of the ISOMETER®.
T/R	Connection for external combined test and reset button
11, 14	Connection to alarm relay "K1"
11, 24	Connection to alarm relay "K2"
A, B	RS-485 communication interface with selectable terminating resistance



*** For UL and CSA applications:**

Feed the supply voltage U_s via 5 A back-up fuses.



For UL applications:

Only use 60/75 °C copper lines.

Wiring diagram

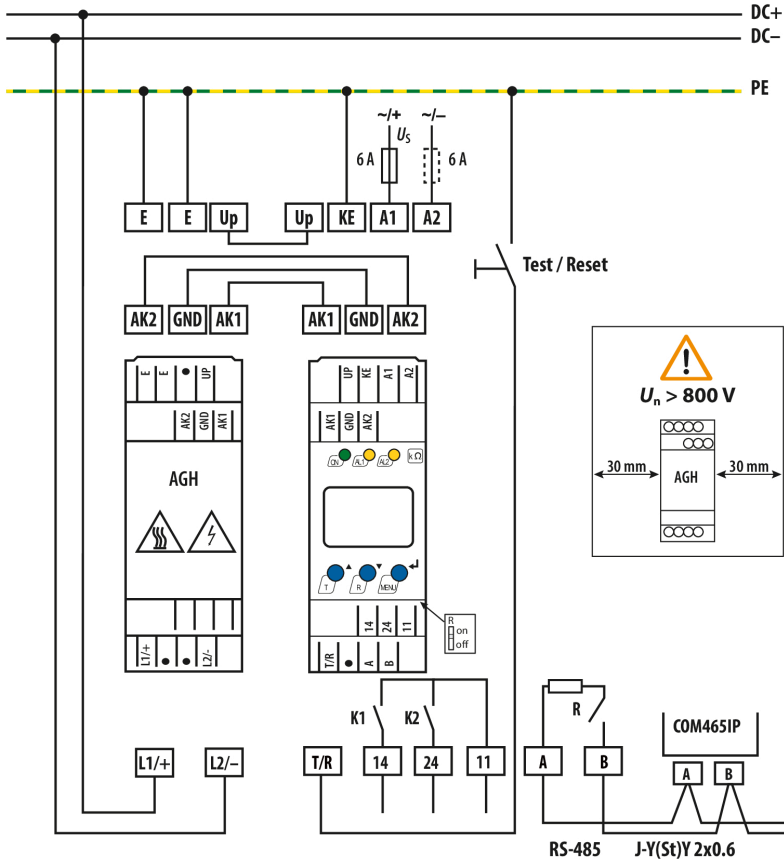

Wiring diagram

3.4 Commissioning

1. **Check that the ISOMETER® is properly connected to the system to be monitored.**
2. **Connect supply voltage U_s to the ISOMETER®.**

The start routine can take up to 30 s. Afterwards, the current insulation resistance is shown as the standard display.



The pulse symbol  signals an error-free update of the resistance and capacitance measured values. If the measured value cannot be updated due to disturbances, the pulse symbol will be blanked.

3. **Set the correct insulation monitoring mode** in the "SEt" menu. The factory setting is "dc".
4. **Start a manual self test** by pressing the test button "T" > 1.5 s. While holding the test button all available display elements are shown. After releasing the button, the test starts and "tES" flashes for the duration of the test. Detected malfunctions are displayed as error codes (see chapter 2.3.12).

i *The alarm relays are not checked during the test (factory setting). The setting can be changed in the "out" menu so that the relays switch to the alarm state during the manual self test.*

5. **Check if the settings are suitable for the system being monitored.**

The list of factory settings is shown in the tables from chapter 4.4.

i *For networks with a leakage capacitance > 5 μ F, the response value R_{an1} should be set to a maximum of 200 k Ω due to the increased measurement tolerance.*





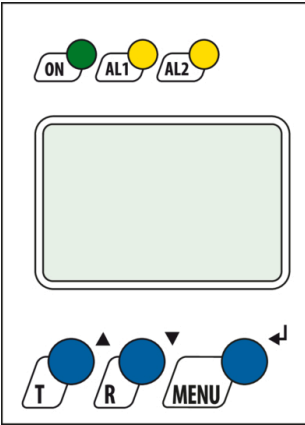

6. **Check the functionality by a real insulation fault.**

Use a suitable resistor to check the ISOMETER® against earth in the system being monitored.

4 Operation

4.1 Operating and display elements

Device front	Operating elements	Function
	ON	Power LED
	AL1 AL2	Alarm LEDs (For codes see “Assigning the alarm messages to the relays”, page 28.)
	▲▼	Up and down buttons – For navigating up or down in the menu settings. – For increasing or decreasing values.
	T	Test button (press > 1.5 s)
	R	Reset button (press > 1.5 s)
	↵	Enter button – Select menu item. – Save value.
MENU	MENU button (press > 1.5 s) – Starts menu mode. – Exits menu item without saving changes.	

Display	Display elements	Function
	U	System voltage U_n
	R	Insulation resistance R_f
	C	System leakage capacitance C_e
	L1 L2 	Monitored conductors
		Voltage type DC
		Pulse symbol: error-free measured value update
		Voltage type AC
	°C μ n F Hz k M Ω % m V A s	Measured values and units
		Password protection is activated
		In the menu mode, the operating mode of the respective alarm relay is displayed.
	Adr	Communication interface with measured value: isoData operation
	M	Fault memory is activated
	test on off	Condition symbols
	> + <	Identification for response values and response value violation

i The display parameters that can be configured flash.

The readability below -25 °C is limited.

Depending on the ISOMETER®'s scope of functions, not all display elements are used.



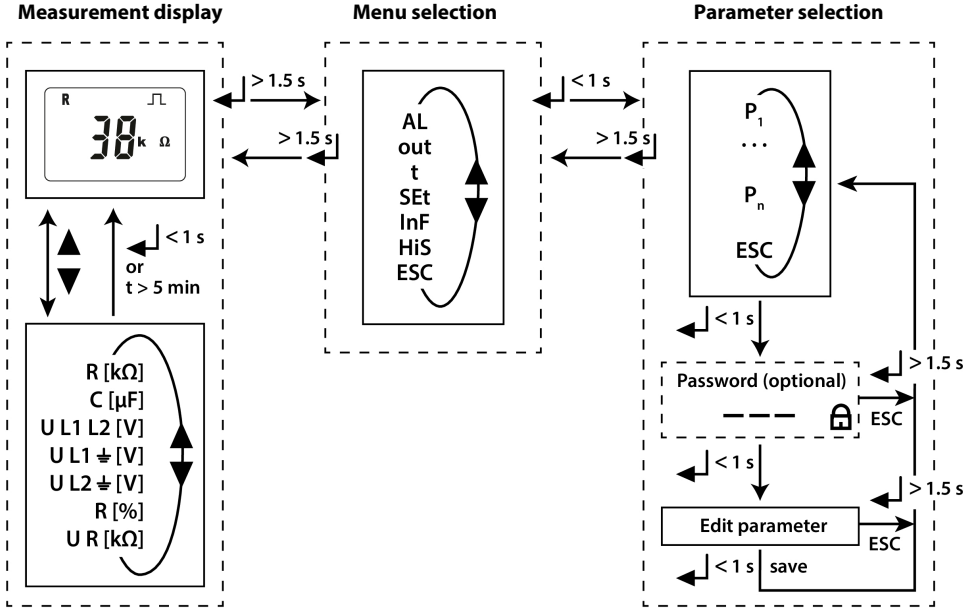

4.2 Menu overview



Menu item	Parameter
AL	Querying and setting response values
out	Configuring fault memory, alarm relays and interface
t	Setting delay times and self test cycles
SEt	Setting device control parameters
InF	Querying software version
HiS	Querying and clearing the history memory
ESC	Going to the next-higher menu level

4.3 Displaying measured values

Overview

HiS	Display	Description
✓	$\pm R \text{ k}\Omega$ 	Insulation resistance R_F 1 k Ω ... 2 M Ω The "+" or "-" sign appears, when an error of $R_F < 500 \text{ k}\Omega$ is mainly detected at L1/+ or L2/- with $ R\% \geq 30 \%$.
✓	$\sim \pm U \text{ L1 L2} = V$	System voltage U_n (L1/+ - L2/-) 0 V_{trueRMS} ... 1200 V_{trueRMS} When $U_{\text{RMS}} > 20 V$, the "+" or "-" sign indicates the polarity at terminals "L1/+" and "L2/-". The sign "~" indicates an AC system.
✓	$\pm U \text{ L1}$  = V	Residual voltage U_{L1e} (L1/+ - PE) DC 0 ... $\pm 1200 V$
✓	$\pm U \text{ L2}$  = V	Residual voltage U_{L2e} (L2/- - PE) DC 0 ... $\pm 1200 V$
-	$\pm R \%$	Fault location in % -100 % ... +100 %
✓	$U \text{ R} = \text{k}\Omega$ 	One-side insulation resistance R_{FU} 1 k Ω ... 2 M Ω calculated from U_{L1e} and U_{L2e} if $U_n > \text{DC } 40 V$

✓ The measured value are displayed in the history memory.

Displaying the current measured values

The standard display shows the currently measured value for R_F . Press the up or down buttons to display the other measured values. After 5 min at the latest the display switches back to the standard display.



ADVICE

The pulse symbol indicates a currently measured value. If this symbol does not appear, the measurement is still ongoing and the latest valid measured value will be displayed. The symbols "<" or ">" will be displayed additionally to the measured value when a response value has been reached or violated, or the measured value is below or above the measuring range.

4.4 Setting the response values (AL)

4.4.1 Response values overview

Display	Activation		Setting value			Description
	FAC	Cs	Range	FAC	Cs	
R1 <	on		R2 ... 600	600	k Ω	Prewarning value R_{an1} Hys. = 25 % min. 1 k Ω
R2 <	on		5 ... R1	120	k Ω	Alarm value R_{an2} Hys. = 25 % min. 1 k Ω

Display	Activation		Setting value			Description
	FAC	Cs	Range	FAC	Cs	
U <	off		10 ... U>	10	V	Alarm value undervoltage Hys. = 5 % min. 5 V
U >	off		U< ... 1.10k	1.10k	V	Alarm value overvoltage Hys. = 5 % min. 5 V
U _e >	off					Alarm value $ U_e > (550 \text{ V or } U_n \times 110 \%)$ Hys. = 7 % min. 40 V
C _e >	off		0.4 ... 5.0	1.5	μF	Alarm value C _e in cable-check Hys. = 10 % min. 0.3 μF

FAC Factory settings

Cs Customer settings

4.4.2 Setting the response values for monitoring the insulation resistance

How to proceed

1. Open menu "AL".
2. Select parameter "R1" for prewarning or parameter "R2" for alarm.
3. Set value and confirm with Enter.

4.4.3 Setting the response values for undervoltage and overvoltage

How to proceed

1. Open menu "AL".
2. Select parameter "U<" for undervoltage or parameter "U>" for overvoltage.
3. Set value and confirm with Enter.

4.4.4 Enable voltage monitoring U_e >

1. Open the "AL" menu.
2. Select the "U_e >" parameter and set to "on".
3. Confirm with Enter.

 Alternatively, voltage monitoring can be enabled via Modbus register 3000 using the "U_e >" parameter..



4.4.5 Set the response value for C_e in the cable-check

1. Open the "AL" menu.
2. Select the "Ce >" parameter and set to "on" if necessary to activate the cable-check.
3. Set the value and confirm with Enter.

4.5 Configuring fault memory, alarm relays, and interfaces (out)

Call up menu „out“ to configure fault memory, alarm relays, and interfaces.

4.5.1 Configuring the relays

Relay K1			Relay K2			Description
Display	FAC	Cs	Display	FAC	Cs	
 1	n/c		 2	n/c		Relay operating mode n/c or n/o



FAC Factory settings

Cs Customer settings

4.5.2 Assigning the alarm messages to the relays

The "on" setting assigns an alarm message to the respective relay. The LED indication is directly assigned to the alarm message and is not related to the relays.

In the event of an unsymmetrical insulation fault, only the alarm message corresponding to the assigned conductor (L1/+ or L2/-) will be displayed.

K1 "r1"			K2 "r2"			LEDs			Description
Display	FAC	Cs	Display	FAC	Cs	ON	AL1	AL2	
 1 Err	off		 2 Err	on		⊙	⊙	⊙	Device error E.xx
r1 +R1 < Ω	on		r2 +R1 < Ω	off		●	●	○	Prewarning R1 Fault R_f at L1/+
r1 -R1 < Ω	on		r2 -R1 < Ω	off		●	●	○	Prewarning R1 Fault R_f at L2/-
r1 +R2 < Ω	off		r2 +R2 < Ω	on		●	○	●	Alarm R2 Fault R_f at L1/+
r1 -R2 < Ω	off		r2 -R2 < Ω	on		●	○	●	Alarm R2 Fault R_f at L2/-
r1 U < V	off		r2 U < V	on		●	○	⊙	Alarm U_n Undervoltage
r1 U > V	off		r2 U > V	on		●	⊙	○	Alarm U_n Overvoltage

K1 "r1"			K2 "r2"			LEDs			Description
Display	FAC	Cs	Display	FAC	Cs	ON	AL1	AL2	
r1 test	off		r2 test	off		●	●	●	Manually started self test
r1 Ce > test	off		r2 Ce > test	on		●	○	◎	Alarm C_e (C_e during cable-check too high)
r1 Ue > V	off		r2 Ue > V	on		●	◎	○	Alarm overvoltage U_e
r1 S.AL	off		r2 S.AL	off		●	●	●	Device start with alarm

FAC Factory settings

Cs Customer settings

○ LED off

◎ LED flashes

● LED on

4.5.3 Activating or deactivating fault memory

Display	FAC	Cs	Description
M	off		Memory function for alarm messages (fault memory)

FAC Factory settings

Cs Customer settings

4.5.4 Configuring interface

Display	Setting value				Description
	Range	FAC	Cs		
Adr	0 / 3 ... 90	3	()	Bus Adr.	Adr = 0 deactivates BMS as well as Modbus and activates isoData with continuous data output (115k2, 8E1)
Adr 1	--- 1.2k ... 115k	19,2k	()	Baud rate	"---": BMS bus (9k6, 7E1) "1.2k" ... "115k": Modbus (variable)
Adr 2	8E1 8o1 8n1 8n2	8E1	()	Modbus	8E1 - 8 data bits, even parity, 1 stop bit 8o1 - 8 data bits, odd parity, 1 stop bit 8n1 - 8 data bits, no parity, 1 stop bit 8n2 - 8 data bits, no parity, 2 stop bits

FAC Factory settings

Cs Customer settings

() Customer setting that is not modified by FAC.



Adr 2 can only be selected, if Adr 1 is not "---".

4.6 Setting delay times and self test cycles / cable-check (t)

Open menu "t" to configure delay times and start times for tests.

Display	Setting value			Description
	Range	FAC	Cs	
t	0...10	0	s	Start-up delay when starting the device
ton	0...99	0	s	Response delay K1 and K2
toff	0...99	0	s	Delay on release K1 and K2
test	OFF/1/24/cbl	OFF	h	Repetition time for self test / enable cable-check

FAC Factory settings

Cs Customer settings

cbl Cable-check (non-cyclic test function)



To comply with the standard UL 2231, the parameter "test" must be "OFF".

4.7 Setting device control parameters (SEt)

Open menu "SEt" to configure the device control.

Display	Activation		Setting value			Description
	FAC	Cs	Range	FAC	Cs	
	off		0..999	0		Password for parameter setting
dc CHd CHA			dc CHd CHA	dc		Insulation monitoring mode dc: CCS $t_{an} \leq 10 \text{ s}$ CHd: CHAdeMO Values R_{FU} , R_{F5} and C_e if $U_n > \text{DC } 50 \text{ V}$ $t_{an} \leq 1 \text{ s}$ if $R_{FU} \leq 100 \text{ k}\Omega$ and $U_n > \text{DC } 100 \text{ V}$ $t_{an} \leq 10 \text{ s}$ if $R_{F5} \leq 160 \text{ k}\Omega$ CHA: CHAdeMO Values R_{FU} and C_e if $U_n > \text{DC } 50 \text{ V}$ $t_{an} \leq 1 \text{ s}$ if $R_{FU} \leq 100 \text{ k}\Omega$ and $U_n > \text{DC } 100 \text{ V}$
nEt			off on on U	on U		System connection test on: if $U_n \leq \text{DC } 100 \text{ V}$ on U: if $U_n > \text{DC } 100 \text{ V}$
S.Ct			off on	off		Self test at device start
FAC						Restore factory settings

Display	Activation		Setting value			Description
	FAC	Cs	Range	FAC	Cs	
SYS						For Bender Service only

FAC Factory settings

Cs Customer settings

4.8 Reset to factory settings

All settings with the exception of the interface parameters are reset to the factory settings.

1. Press MENU button (> 1.5 s).
2. Go to "SEt" and confirm with Enter.
3. Go to "FAC" and confirm with Enter.

4.9 Showing and deleting the history memory



ADVICE

The history memory saves the measured values for the first fault only. To this end, the history memory must be empty.

Show history memory

Call up "HiS" menu and go up or down.

Delete history memory

Call up "HiS" menu, go to "Clr" and confirm.

4.10 Querying software version (InF)

The software version is displayed as a ticker. Afterwards it can be output step by step using the up or down buttons.

How to proceed

1. Press MENU button (> 1.5 s).
2. Go to "InF" and confirm with Enter.
3. If necessary, use up or down buttons to display it step by step.

5 Data access via RS-485 interface

5.1 Data access using the BMS protocol

The BMS protocol is an essential component of the Bender measuring device interface (BMS bus protocol). Data transmission generally makes use of ASCII characters.

BMS channel no.	Operation value	Alarm
1	R_F	Prewarning R1
2	R_F	Alarm R2
3		
4	U_n	Undervoltage
5	U_n	Overvoltage
6		Connection fault, earth (E.01)
7		Connection fault, system (E.02)
8		All other device faults (E.xx)
9	Fault location [%]	
10	C_e	
11		
12	Update counter	
13	U_{L1e}	
14	U_{L2e}	
15	R_{FU}	

5.2 Data access using the Modbus RTU protocol

Requests to the ISOMETER® can be made using the function code 0x03 (read multiple registers) or the command 0x10 (write multiple registers). The ISOMETER® generates a function-related answer and sends it back.

5.2.1 Reading out the Modbus register from the ISOMETER®

The required Words of the process image can be read out from the ISOMETER® "Holding Registers" using function code 0x03. For this purpose, the start address and the number of the registers to be read out must be entered. Up to 125 Words (0x7D) can be read out with one single request.

Command of the master to the ISOMETER®

In the following example, the master of the ISOMETER® requests the content of register 1003 using address 3. The register contains the channel description of measuring channel 1.

Byte	Name	Example
Byte 0	ISOMETER® Modbus address	0x03
Byte 1	Function code	0x03
Byte 2, 3	Start address	0x03EB
Byte 4, 5	Number of registers	0x0001
Byte 6, 7	CRC16 checksum	0xF598

Answer of the ISOMETER® to the master

Byte	Name	Example
Byte 0	ISOMETER® Modbus address	0x03
Byte 1	Function code	0x03
Byte 2	Number of data bytes	0x02
Byte 3, 4	Data	0x0047
Byte 7, 8	CRC16 checksum	0x81B6

5.2.2 Writing the Modbus register (parameter setting)

Registers in the device can be modified with function code 0x10 (set multiple registers). Parameter registers start with address 3000. For the contents of the registers, see table in chapter 5.3.2.1.

The master sends a command to the ISOMETER®

In this example, address 3 is used to set the content of register address 3003 to 2.

Byte	Name	Example
Byte 0	ISOMETER® Modbus address	0x03
Byte 1	Function code	0x10
Byte 2, 3	Start register	0x0BBB
Byte 4, 5	Number of registers	0x0001
Byte 6	Number of data bytes	0x02
Byte 7, 8	Data	0x0002
Byte 9, 10	CRC16 checksum	0x9F7A

Response of the ISOMETER® to the master

Byte	Name	Example
Byte 0	ISOMETER® Modbus address	0x03
Byte 1	Function code	0x10
Byte 2, 3	Start register	0x0BBB
Byte 4, 5	Number of registers	0x0001
Byte 6, 7	CRC16 checksum	0x722A

5.2.3 Exception code

If the ISOMETER® cannot respond to a request, it will send an exception code with which possible faults can be narrowed down.

Exception code	Description
0x01	Impermissible function
0x02	Impermissible data access
0x03	Impermissible data value
0x04	Internal fault
0x05	Acknowledgement of receipt (answer will be time-delayed)
0x06	Request not accepted (repeat request if necessary)

Structure of the exception code

Byte	Name	Example
Byte 0	ISOMETER® Modbus address	0x03
Byte 1	Function code (0x03) + 0x80	0x83
Byte 2	Data (exception code)	0x04
Byte 3, 4	CRC16 checksum	0xE133

5.3 Modbus register assignment

5.3.1 Modbus measured value registers

Depending on the device condition, the information in the registers is the measured value without alarm, the measured value with alarm 1, the measured value with alarm 2, or the device error. For more information see , page 36.

Register	Measured value			Device error
	Without alarm	Alarm 1 [prewarning]	Alarm 2 [alarm]	
1000...1003	R_F Insulation fault (71)	R_F Insulation fault (1)	R_F Insulation fault (1)	Earth connection (102)

Register	Measured value			Device error
	Without alarm	Alarm 1 [prewarning]	Alarm 2 [alarm]	
1004...1007				
1008...1011	U_n Voltage (76)	U_n Undervoltage (77) [alarm]	U_n Overvoltage (78)	Connection to system (101)
1012...1015	C_e Capacitance (82)			
1016...1019	U_{L1e} Voltage (76)	U_e Overvoltage (78) [Alarm]		
1020...1023	U_{L2e} Voltage (76)	U_e Overvoltage (78) [Alarm]		
1024...1027	Fault location in % (1022)			
1028...1031	R_{FU} Insulation fault (71)			
1032...1035	Measured value update counter (1022)			Device error (115)

() channel description code (see "Channel descriptions", page 38)

5.3.1.1 Measurement coding

Each measured value is available as a channel and consists of 8 bytes (4 registers). The first measured value register address is 1000. The structure of a channel is always the same. Content and number depend on the device. The structure of a channel is shown with the example of channel 1:

1000		1001		1002		1003	
HiByte	LoByte	HiByte	LoByte	HiByte	LoByte	HiByte	LoByte
Floating point value (Float)				Alarm type and test type (AT&T)	Range and unit (R&U)	Channel description	

5.3.1.2 Float = Floating point value of the channels

Representation of the bit order for processing analogue measured values according to IEEE 754

Word	0x00																0x01															
Byte	HiByte								LoByte								HiByte								LoByte							
Bit	31	30	29	28	27	26	25	24	23	22	21	20	19	18	17	16	15	14	13	12	11	10	9	8	7	6	5	4	3	2	1	0
	S	E	E	E	E	E	E	E	E	E	M	M	M	M	M	M	M	M	M	M	M	M	M	M	M	M	M	M	M	M	M	M

E exponent

M mantissa

S sign

5.3.1.3 AT&T = Alarm type and test type (internal/external)

Bit	7	6	5	4	3	2	1	0	Meaning
	Test external	Test internal	Reserved	Reserved	Reserved	Alarm	Fault		
Alarm type	X	X	X	X	X	0	0	0	No alarm
	X	X	X	X	X	0	0	1	Prewarning
	0	0	X	X	X	0	1	0	Device error
	X	X	X	X	X	0	1	1	Reserved
	X	X	X	X	X	1	0	0	Warning
	X	X	X	X	X	1	0	1	Alarm
	X	X	X	X	X	1	1	0	Reserved
	X	X	X	X	X	1	1	1	Reserved
Test	0	0	X	X	X	X	X	X	No test
	0	1	X	X	X	X	X	X	Internal test
	1	0	X	X	X	X	X	X	External test

- Bits 0 to 2: coding for the alarm type
- Bits 3 to 5: reserved; value 0
- Bit 6 oder 7: set when an internal or external test is active

Other values are reserved. The complete byte is calculated from the sum of the alarm type and the test type.

5.3.1.4 R&U = Range and unit

Bit	7	6	5	4	3	2	1	0	Meaning
Unit	-	-	-	0	0	0	0	0	Invalid (init)
	-	-	-	0	0	0	0	1	No unit
	-	-	-	0	0	0	1	0	Ω
	-	-	-	0	0	0	1	1	A
	-	-	-	0	0	1	0	0	V
	-	-	-	0	0	1	0	1	%
	-	-	-	0	0	1	1	0	Hz
	-	-	-	0	0	1	1	1	Baud
	-	-	-	0	1	0	0	0	F
	-	-	-	0	1	0	0	1	H
	-	-	-	0	1	0	1	0	°C
	-	-	-	0	1	0	1	1	°F
	-	-	-	0	1	1	0	0	Second
	-	-	-	0	1	1	0	1	Minute
	-	-	-	0	1	1	1	0	Hour
-	-	-	0	1	1	1	1	Day	
-	-	-	1	0	0	0	0	Month	
Range of validity	0	0	X	X	X	X	X	X	Actual value
	0	1	X	X	X	X	X	X	The actual value is lower
	1	0	X	X	X	X	X	X	The actual value is higher
	1	1	X	X	X	X	X	X	Invalid value

- Bits 0 to 4: coding for the unit
- Bits 6 and 7: validity range of a value
- Bit 5: reserved

The complete byte is calculated from the sum of the unit and the range of validity.

5.3.1.5 Channel descriptions

Value	Description of measured value / message	Comments
0		
1 (0x01)	Insulation fault	
71 (0x47)	Insulation fault	Insulation resistance R_F in Ω
76 (0x4C)	Voltage	Measured value in V
77 (0x4D)	Undervoltage	
78 (0x4E)	Overvoltage	
82 (0x52)	Capacitance	Measured value in F
86 (0x56)	Insulation fault	Impedance Z_i
101 (0x65)	System connection	
102 (0x66)	Earth connection	
115 (0x73)	Device error	ISOMETER® fault
129 (0x81)	Device error	
145 (0x91)	Own address	

5.3.2 Modbus parameter register

5.3.2.1 Parameter coding

Register	Property	Description	Format	Unit	Value range
996 ... 997	RO	Device error: E.32 ... E.04 E.03 E.02 E.01 Bit: 31 ... 3 2 1 0	UINT 32		UINT 32
998	RO	Message: S.AL Ue> Ce> test U> U< Bit: 11 10 9 8 7 6 -R2< +R2< -R1< +R1< Err - 5 4 3 2 1 0	UINT 16		UINT 16
999	RO	Number of Modbus measured-value channels with active alarm	UINT 16		0...6
3000	RW	Activation overvoltage U_e	UINT 16		0 = off 1 = on
3001	RW	Reserved			
3002	RW	Activation of alarm value C_e „Cable-check“	UINT 16		0 = off 1 = on
3003	RW	Alarm value C_e during „Cable-check“ 0.4 μ F ... 5.0 μ F		1/10 μ F	4 ... 50
3004	RW	Reserved			
3005	RW	Prewarning value resistance measurement “R1”	UINT 16	k Ω	R2 ... 600

Register	Property	Description	Format	Unit	Value range
3006	RW	Reserved			
3007	RW	Alarm value resistance measurement "R2"	UINT 16	kΩ	5 ... R1
3008	RW	Activation alarm value undervoltage "U<"	UINT 16		0 = off 1 = on
3009	RW	Alarm value undervoltage "U<"	UINT 16	V	10 ... U>
3010	RW	Activation alarm value overvoltage "U>"	UINT 16		0 = off 1 = on
3011	RW	Alarm value overvoltage "U>"	UINT 16	V	U< ... 1100
3012	RW	Memory function for alarm messages (fault memory) "M"	UINT 16		0 = off 1 = on
3013	RW	Operating mode of relay K1 "r1"	UINT 16		0 = n/o 1 = n/c
3014	RW	Operating mode of relay K2 "r2"	UINT 16		0 = n/o 1 = n/c
3015	RW	Bus address "Adr"	UINT 16		0 / 3...90
3016	RW	Baud rate "Adr 1"	UINT 16		0 = BMS 1 = 1.2 k 2 = 2.4 k 3 = 4.8 k 4 = 9.6 k 5 = 19.2 k 6 = 38.4 k 7 = 57.6 k 8 = 115.2 k
3017	RW	Parity "Adr 2"	UINT 16		0 = 8N1 1 = 8O1 2 = 8E1 3 = 8N2
3018	RW	Start-up delay "t" during device start	UINT 16	s	0 ... 10
3019	RW	Response delay "ton" for relays "K1" and "K2"	UINT 16	s	0 ... 99
3020	RW	Delay on release "toff" for relays "K1" and "K2"	UINT 16	s	0 ... 99
3021	RW	Repetition time "test" for automatic self test cbl: test function adapted for "Cable-check"; carried out when exiting stop mode or via the "start self test" command	UINT 16		0 = off 1 = 1 h 2 = 24 h 3 = cbl
3022	RW	Reserved			
3023	RW	Insulation monitoring mode	UINT 16		0 = dc 1 = CHd 2 = CHA

Register	Property	Description	Format	Unit	Value range
3024	RW	Test of the system connection during self test "nEt"	UINT 16		0 = off 1 = on 2 = on U
3025	RW	Self test during device start "S.Ct"	UINT 16		0 = off 1 = on
3026	RW	Request stop mode (0 = deactivate devices)	UINT 16		0 = Stop 1 = ---
3027	RW	Alarm assignment of relay K1 "r1" Message: S.AL Ue> Ce> test U> U< Bit: 11 10 9 8 7 6 -R2< +R2< -R1< +R1< Err - 5 4 3 2 1 0	UINT 16		UINT 16
3028	RW	Alarm assignment of relay K2 "r2" For messages see register 3027.	UINT 16		UINT 16
8003	WO	Factory settings for all parameters	UINT 16		0x6661 "fa"
8004	WO	Factory setting only for parameters resettable by FAC	UINT 16		0x4653 "FS"
8005	WO	Start self test	UINT 16		0x5445 "TE"
8006	WO	Reset command	UINT 16		0x434C "CL"
9800 ... 9809	RO	Device name (ASCII)	UNIT 16		
9820	RO	Software identification number	UINT 16		
9821	RO	Software version number	UINT 16		
9822	RO	Software version: Year	UINT 16		
9823	RO	Software version: Month	UINT 16		
9824	RO	Software version: Day	UINT 16		
9825	RO	Modbus driver version	UINT 16		

RO Read only

RW Read/Write

WO Write only

5.3.2.2 Alarm assignment of the relays

Several messages and alarms can be assigned to each relay. For the assignment to each relay, a 16-bit register is used with the bits described below. The following table applies to relay K1 and relay K2, in which “x” stands for the relay number. A set bit activates the specified function.

Bit	Display indication	Meaning
0	Reserved	When reading: 0 When writing: any value
1	 x Err	Device error E.xx
2	rx +R1 < Ω	Prewarning R1 - Fault R_f at L1/+
3	rx -R1 < Ω	Prewarning R1 - Fault R_f at L2/-
4	rx +R2 < Ω	Alarm R2 - Fault R_f at L1/+
5	rx -R2 < Ω	Alarm R2 - Fault R_f at L2/-
6	rx U < V	Alarm message U_n - undervoltage
7	rx U > V	Alarm message U_n - overvoltage
8	rx test	Manually started self test
9	rx Ce >	Alarm C_e during cable-check too high
10	rx Ue >	Alarm overvoltage U_e
11	rx S.AL	Device start with alarm
12...15	Reserved	When reading: 0 When writing: any value

5.3.2.3 Device name

The data format of the device name consists of ten Words with two ASCII characters each.

0x00	0x01	0x02	0x03	0x04	0x05	0x06	0x07	0x08	0x09
------	------	------	------	------	------	------	------	------	------

5.4 IsoData data string

In IsoData mode the ISOMETER® sends the entire data string roughly once per second. Communication with the ISOMETER® in this mode is not possible and no additional sender may be connected via the RS-485 bus cable.

IsoData is activated in the menu "out", menu item "Adr", when Adr is set to 0. In this case, the "Adr" symbol flashes on the measured value display.

String	Description
;	Start symbol
v;	Insulation fault location " " / "+" / "-"
123456;	Insulation resistance R_F [k Ω]
12345;	System leakage capacitance C_e [nF]
123456;	Reserved
+1234;	System voltage U_n [V_{trueRMS}] System voltage type: AC or unknown: " " DC: "+" / "-"
+1234;	System voltage U_{L1e} [V_{DC}]
+1234;	System voltage U_{L2e} [V_{DC}]
+123;	Insulation fault location -100 ... +100 [%]
123456;	Insulation resistance R_{FU} [k Ω]
1234;	Alarm message [hexadecimal] (without leading "0x") The alarms are included in this value with the OR function. Assignment of the alarms: 0x0002 device error 0x0004 Prewarning insulation resistance R_F at L+ 0x0008 Prewarning insulation resistance R_F at L- 0x000C Prewarning insulation resistance R_F symmetrical 0x0010 Alarm insulation resistance R_F at L+ 0x0020 Alarm insulation resistance R_F at L- 0x0030 Alarm insulation resistance R_F symmetrical 0x0040 Alarm undervoltage U_n 0x0080 Alarm overvoltage U_n 0x0100 Message manually started self test 0x0200 Alarm C_e during cable-check too high 0x0400 Alarm overvoltage U_e 0x0800 Device start with alarm
12	Update counter, consecutively counts from 0 to 99. It increases with the update of the insulation resistance value.
<CR><LF>	String end

6 Technical data

6.1 Technical data isoCHA425HV

()* = factory settings

Insulation coordination acc. to IEC 60664-1/-3

Definitions

Supply circuit (IC2)	A1, A2
Output circuit (IC3)	11, 14, 24
Control circuit (IC4)	Up, KE, T/R, A, B, AK1, GND, AK2
Rated voltage	240 V
Overvoltage category	III

Rated impulse voltage

IC2/(IC3-4)	4 kV
IC3/IC4	4 kV

Rated insulation voltage

IC2/(IC3-4)	250 V
IC3/IC4	250 V
Pollution degree	3

Protective separation (reinforced insulation) between

IC2/(IC3-4)	overvoltage category III, 300 V
IC3/IC4	overvoltage category III, 300 V

Voltage tests (routine test) acc. to IEC 61010-1

IC2/(IC3-4)	DC ± 3.1 kV
IC3/IC4	AC 2.2 kV

Supply voltage

Supply voltage U_s	AC 100...240 V / DC 24...240 V
Tolerance of U_s	-30...+15 %
Frequency range U_s	47...63 Hz
Power consumption	≤ 3 W, ≤ 9 VA

IT system being monitored

Nominal system voltage U_n with AGH420-1/AGH421-1	DC 0...1000 V
Tolerance of U_n	+10 %
Nominal system voltage range U_n with AGH420-1/AGH421-1 (UL 508)	DC 0...600 V

Response values

Response value R_{an1}	$R_{an2} \dots 600 \text{ k}\Omega$ (600 k Ω)*
Response value R_{an2}	5 k $\Omega \dots R_{an1}$ (120 k Ω)*
Hysteresis R_{an}	25 %, > 1 k Ω
Undervoltage detection $U_n <$	10...1090 V (off)*
Overvoltage detection $U_n >$	11...1100 V (off)*
Overload detection $U_n >$	1200 V (cannot be deactivated)
Hysteresis U_n	5 %, > 5 V
Overvoltage detection $U_e >$	$U_n \times 110$ %, at least 550 V (off)*
Hysteresis U_e	7 %, > 40 V

System voltage

Measuring range	DC ± 1200 V
Display range	0 V...1.2 kV (measurement True-RMS)
Measurement and relative uncertainty	± 5 %, > ± 5 V

Mode CCS (dc)

Permissible system leakage capacitance C_e	$\leq 20 \mu\text{F}$
Permissible system leakage capacitance C_e acc. to UL 2231-1/-2	$\leq 10 \mu\text{F}$
Measuring and display range R_F	1 k Ω ... 2 M Ω
Measurement uncertainty R_F / relative uncertainty R_{an}	
$C_e \leq 5 \mu\text{F}$	± 15 %, $\pm 2 \text{ k}\Omega$
$C_e > 5 \mu\text{F}$ and $R_F > 100 \text{ k}\Omega$	$\pm(5 \% \times R_{an} / 100 \text{ k}\Omega + 10 \%)$
Measuring and display range C_e	0...35 μF
Measurement uncertainty C_e	
$R_F < 10 \text{ k}\Omega$	no measurement
$R_F \geq 10 \text{ k}\Omega$	± 15 %, $\pm 0.1 \mu\text{F}$

Response time t_{an}

$R_{an} = 2.0 \times R_F$ and $C_e = 1 \mu\text{F}$ acc. to IEC 61557-8	$\leq 10 \text{ s}$
$R_{an} = 2.0 \times R_F$ and $C_e \leq 5 \mu\text{F}$ or $R_F \leq 100 \text{ k}\Omega$	$\leq 10 \text{ s}$

Mode CHAdeMO (CHd and CHA)

 System voltage U_n measurement from $U_n \geq \text{DC } 50 \text{ V}$

 Permissible system leakage capacitance C_e per conductor $\leq 1.6 \mu\text{F}$

One-pole fault R_{FU}

 Measuring and display range R_{FU} 1 k Ω ... 2 M Ω

 Measurement uncertainty R_{FU} / relative uncertainty R_{an}
 $U_n \geq 100 \text{ V}$ and $R_{FU} \leq 200 \text{ k}\Omega$ $\pm 15 \%$, $\pm 2 \text{ k}\Omega$
 $U_n \geq 200 \text{ V}$ $\pm 15 \%$, $\pm 2 \text{ k}\Omega$

Two-pole fault R_{FS} (only CHd Mode)

 Measuring and display range R_{FS} 1...160 k Ω

 Measurement uncertainty R_{FS} / relative uncertainty R_{an}
 $< 160 \text{ k}\Omega$ $\pm 15 \%$, $\pm 2 \text{ k}\Omega$

 Measuring and display range C_e 0...35 μF

 Measurement uncertainty C_e
 $R_F < 10 \text{ k}\Omega$ no measurement
 $R_F \geq 10 \text{ k}\Omega$ $\pm 15 \%$, $\pm 0.1 \mu\text{F}$

 Response time t_{an}
 $R_{an} = 1.2 \times R_{FU}$ and $R_{FU} \leq 100 \text{ k}\Omega$ and $U_n > 100 \text{ V}$ $\leq 1 \text{ s}$
 $R_{an} = 1.2 \times R_F$ $\leq 10 \text{ s}$

Displays, memory

 Password off / 0...999 (off / 0)*

 Fault memory alarm messages on/(off)*

 Display LC display, multifunctional, not illuminated

Time response

Start-up delay t	0...10 s (0 s)*
Response delay t_{on}	0...99 s (0 s)*
Delay on release t_{off}	0...99 s (0 s)*

Interface

Interface / protocol	RS-485 / BMS, Modbus RTU, isoData
Baud rate	BMS (9.6 kBit/s), Modbus RTU (selectable), isoData (115.2 kBits/s)
Cable length (9.6 kBits/s)	≤ 1200 m
Cable: twisted pairs	min. J-Y(St)Y 2 × 0.6
Terminating resistor	120 Ω (0.25 W), internal, can be connected
Device address, BMS bus, Modbus RTU	3...90 (3)*

Switching elements

Switching elements	2 × 1 n/o contact, common terminal 11
Operating principle	n/c operation, n/o operation (n/c operation)*
Electrical endurance under rated operating conditions	10,000 cycles

Contact data acc. to IEC 60947-5-1

Utilisation category	AC-12 / AC-14 / DC-12 / DC-12 / DC-12
Rated operational voltage	230 V / 230 V / 24 V / 110 V / 220 V
Rated operational current	5 A / 2 A / 1 A / 0.2 A / 0.1 A
Minimum contact load	1 mA at DC ≥ 5 V

Contact data acc. to UL 508

Rated operational voltage	AC 250 V
Rated operational current	2 A

Environment/EMC

EMC	IEC 61326-2-4; IEC 61851-21-2:2018-04 Ed. 1.0
-----	-----------------------------------------------

Ambient temperatures

Operation	-40...+70 °C ¹⁾
Transport	-40...+85 °C
Storage	-40...+70 °C

1) Below -25 °C the readability of the display is limited.

Classification of climatic conditions acc. to IEC 60721 (related to temperature and relative humidity)

Stationary use (IEC 60721-3-3)	3K22
Transport (IEC 60721-3-2)	2K11
Long-term storage (IEC 60721-3-1)	1K22

Classification of mechanical conditions acc. to IEC 60721

Stationary use (IEC 60721-3-3)	3M11
Transport (IEC 60721-3-2)	2M4
Long-term storage (IEC 60721-3-1)	1M12

Other

Operating mode	continuous operation
Mounting	cooling slots must be ventilated vertically
Degree of protection, built-in components (DIN EN 60529)	IP30
Degree of protection, terminals (DIN EN 60529)	IP20
Enclosure material	polycarbonate
DIN rail mounting acc. to	IEC 60715
Screw mounting	2 × M4 with mounting clip
Weight	≤ 150 g

6.2 Technical data AGH420-1 and AGH421-1

Insulation coordination acc. to IEC 60664-1/-3

Definitions

Measuring circuit (IC1)	L1/+, L2/-
Control circuit (IC2)	AK1, GND, AK2, Up, E
Rated voltage	1000 V
Overvoltage category	III

Rated impulse voltage

IC1/IC2	8 kV
---------	------

Rated insulated voltage

IC1/IC2	1000 V
Polution degree	3

Protective separation (protective impedance) between

IC1/IC2	Overvoltage category III, 1000 V
---------	----------------------------------

Monitored IT system

Nominal system voltage range U_n	DC 0...1000 V
Tolerance of U_n	+10 %
Nominal system voltage range U_n (UL 508)	DC 0...600 V

Measuring circuit

Measuring voltage U_m	± 45 V
Measuring current I_m at $R_F = 0 \Omega$	$\leq 400 \mu\text{A}$
Internal resistance R_i	$\geq 120 \text{k}\Omega$

Environment/EMC

EMC	IEC 61326-2-4
-----	---------------

Ambient temperatures

Operation	-40...+70 °C
Transport	-40...+85 °C
Storage	-40...+70 °C

Classification of climatic conditions acc. to IEC 60721 (related to temperature and relative humidity)

Stationary use (IEC 60721-3-3)	3K22
Transport (IEC 60721-3-2)	2K11
Long-term storage (IEC 60721-3-1)	1K22

Classification of mechanical conditions acc. to IEC 60721

Stationary use (IEC 60721-3-3)	3M11
Transport (IEC 60721-3-2)	2M4
Long-term storage (IEC 60721-3-1)	1M12

Other

Operating mode	continuous operation
Mounting	cooling slots must be ventilated vertically
Distance to adjacent devices from $U_n > 800$ V	≥ 30 mm
Degree of protection internal components (DIN EN 60529)	IP30
Degree of protection terminals (DIN EN 60529)	IP20
Enclosure material	polycarbonate
DIN rail mounting acc. to	IEC 60715
Screw mounting	2 x M4 with mounting clip
Weight	≤ 150 g

6.3 Connection (for ISOMETER® and AGH)
Push-wire terminals

Nominal current	≤ 10 A
Conductor sizes	AWG 24...14
Stripping length	10 mm
Rigid	0.2...2.5 mm ²
Flexible without ferrules	0.75...2.5 mm ²
Flexible with ferrules with/without plastic sleeve	0.25...2.5 mm ²
Multi-conductor flexible with TWIN ferrules with plastic sleeve	0.5...1.5 mm ²
Opening force	50 N
Test opening	Ø 2.1 mm

Single cables for terminals Up, AK1, GND, AK2

Requirement for connecting cables between ISOMETER® and AGH

Cable lengths	≤ 0.5 m
Connection properties	≥ 0.75 mm ²

6.4 Standards and certifications

The ISOMETER® was developed in compliance with the following standards:

- IEC 61851-23:2023
- IEC 61851-21-2: 2018-04 Version 1.0
- IEC 61557-8 Edition 3.0 2014-12
- DIN EN 61557-8:2015
- UL 2231-1 Edition 2 2012-09 Rev 2021-09
- UL 2231-2 Edition 2 2012-09 Rev 2020-12

Subject to change! The specified standards take into account the edition valid until 04.02.2025 unless otherwise indicated.



EU Declaration of Conformity

The EU Declaration of Conformity is available at the following Internet address:

https://www.bender.de/fileadmin/content/Products/CE/CEKO_isoXX425.pdf

UKCA Declaration of Conformity

The UKCA Declaration of Conformity is available at the following Internet address:

https://www.bender.de/fileadmin/content/Products/UKCA/UKCA_isoXX425.pdf

6.5 Ordering data

ISOMETER®

Type	Nominal voltage U_n	Article number	
		Set	Contents
isoCHA425HV-D4-4 + AGH420-1	CCS: DC 0...1000 V CHAdEMO: DC 50...1000 V	B71036396	B71036394 B78039033
isoCHA425HV-D4-4 + AGH421-1	CCS: DC 0...1000 V CHAdEMO: DC 50...1000 V	B71036399	B71036394 B78039034

Accessories

Description	Article number
Mounting clip for screw mounting	B98060008
XM420 mounting frame	B990994

6.6 Document revision history

Date	Document version	Valid from software	State/Changes
11/2021	02	D624 V1.00	Added: Data about Mode CHA in chapter Device features RF and Ce in Mode „CHd“ and „CHA“ (CHAdEMO) Menu „SEt“ Modbus register assignment of the ISOMETER® (at register 3032) Info about screw terminal in Technical Data (at AGH420-1) Ordering information Changes: Chapter Menu „AL“ Description LED on / off
02/2023	03	D624 V4.02	Editorial revision 3.1 Dimension drawing new 3.3 Connection diagram new 3.4 Setting insulation monitoring mode incl. note 4.1 Note „Readability ...“ 4.5.1 Note „To comply with UL2231 ...“ 9.0 TD: ModeCCS (dc), climatic classes 9.1 Climate classes; UL2231 9.3 EU conformity 9.4 Modification history
10/2023	04	"	Editorial revision <ul style="list-style-type: none"> • Transfer to SMC incl. new chapter structure • Separation of descriptive and instructional texts (function/operation) Changed: Table 'Modbus register assignment': Overvoltage and undervoltage swapped. Updated: UL2231-1/-2 to 10 µF Added: AGH421-1
04/2024	05	"	Update of standard IEC 61851-23: Edition 1.0 2014-03 > 2023 ED2

Date	Document version	Valid from software	State/Changes
01/2025	06	D624 V5.02	<p>New software with the functions</p> <ul style="list-style-type: none"> • “Cable-Check”, page 14; see also “Set the response value for C_e in the cable-check”, page 28 • “Voltage monitoring $U_{e>}>$”, page 12; see also “Enable voltage monitoring $U_{e>}>$”, page 27 <p>New</p> <ul style="list-style-type: none"> • “Reset command (delete fault memory)”, page 16 <p>Updated</p> <ul style="list-style-type: none"> • “IsoData data string”, page 42 • “Alarm assignment of the relays”, page 41 • “Parameter coding”, page 38 (Register 996...999; 3000; 3002; 3003; 3021; 3027; 3028; 8006) • “Assigning the alarm messages to the relays”, page 28 • “Setting delay times and self test cycles / cable-check (t)”, page 30 • “Response values overview”, page 26 • Redundancies removed in “External test/reset button (T/R)”, page 18



Bender GmbH & Co. KG

Londorfer Straße 65
35305 Grünberg
Germany

Tel.: +49 6401 807-0
info@bender.de
www.bender.de

Alle Rechte vorbehalten.
Nachdruck und Vervielfältigung nur mit
Genehmigung des Herausgebers.

All rights reserved.
Reprinting and duplicating only with
permission of the publisher.



© Bender GmbH & Co. KG, Germany
Subject to change! The specified
standards take into account the edition
valid until 01.2025 unless otherwise
indicated.